



NEW 24"/30"/36"W. INTEGRATED ALL REFRIGERATOR

FDREIC

PROFESSIONAL FEATURES

- Uniform air circulation maintains consistent temperatures
 - Ensures food stored in different compartments gets equal treatment
 - Maintains temperature to within 1°F to keep food fresher longer
- Extremely quiet compressor system with electronic controls
- Compressor located on the bottom allows for full integration of the product
- Temperature Range: 34°F (1°C) to 45°F (7°C)
- Antibacterial stainless steel interior crisper drawers
 - Stainless steel non-porous surface is micro peened to resist bacteria and germs
 - Helps maintain high food quality and shields against the spread of bacteria
 - Inside corners of drawers have a radius for easy cleaning
- Three crisper drawers operate at a temperature 2°F to 3°F lower than the rest of the refrigerator
- State-of-the-art closing system ensures refrigerator crisper drawers close smoothly and quietly
- **EXCLUSIVE PlasmaCluster™ Ion Air Purifier** utilizes advanced ion technology to eliminate airborne bacteria, mold, and odors
- Easy user interface allows for personalization of settings
 - Special Modes include Max Refrigerator, Vacation, Sabbath
- Side and top mounted energy-efficient LED lighting enhances visibility
- Filtered fresh water at the touch of a button (30" and 36" models)
- *Patented Easy Lift Shelf Position System* adds storage flexibility
- Three adjustable glass shelves, one fixed glass shelf, three adjustable door bins

DESIGN FEATURES

- *Proprietary Fully Articulating Hinge* has three-dimensional adjustability for a perfect fit in integrated installations
- Hinge damper allows for smoothness when opening and closing door
- Unit is custom panel ready to accept matching cabinetry panels or the Viking Professional and RVL Door Panel Kits



FDREIC7360L
(shown with custom panel)

MODEL NUMBERS

- FDREIC7240L – 24"W. Integrated All Refrigerator, Custom Panel; Left Hinge
- FDREIC7240R – 24"W. Integrated All Refrigerator, Custom Panel; Right Hinge
- FDREIC7300L – 30"W. Integrated All Refrigerator, Custom Panel; Left Hinge
- FDREIC7300R – 30"W. Integrated All Refrigerator, Custom Panel; Right Hinge
- FDREIC7360L – 36"W. Integrated All Refrigerator, Custom Panel; Left Hinge
- FDREIC7360R – 36"W. Integrated All Refrigerator, Custom Panel; Right Hinge

ACCESSORIES

- PHK528-SS – Professional Stainless Steel handle (1 piece/28")
- RWFIC – Replacement Water Filter

WARRANTY

- 2-year full covers complete unit
- 6-year full – sealed refrigeration system
- 90-day full – cosmetic parts such as glass, painted items, and decorative items
- 12-year limited – sealed refrigeration system



NEW 24"/30"/36"W. INTEGRATED ALL REFRIGERATOR

FDREIC

PROFESSIONAL DOOR PANEL KITS

- VI724CDP* – 24"W. Integrated Column Door Panel Kit with Handle, Field Reversible
- VI730CDP* – 30"W. Integrated Column Door Panel Kit with Handle, Field Reversible
- VI736CDP* – 36"W. Integrated Column Door Panel Kit with Handle, Field Reversible

DOOR PANEL COLOR FINISHES*

- Stainless Steel (SS)



- Available in 18 Exclusive Color Finishes: Antique Bronze (AN), Blush (BH), Cast Black (CS), Daffodil (DA), Damascus Gray (DG), Eucalyptus (EU), Golden Hour (GH), Ivy (IV), Martini (MA), Nantucket (NA), November Sky (NS), Onyx (ON), Pure White (PW), Slate Blue (SB), Spiced Cider (SC), Splash (SP), Squall (SQ), and Valentine (VA)



RVL DOOR PANEL KITS

- MVI624CDP(R/L)** – 24"W. Column Door Panel Kit with Handle, Right or Left Hinge
- MVI630CDP(R/L)** – 30"W. Column Door Panel Kit with Handle, Right or Left Hinge
- MVI636CDP(R/L)** – 36"W. Column Door Panel Kit with Handle, Right or Left Hinge

RVL DOOR PANEL FINISHES**

- Black Glass (BG) and Stainless Steel (SS)



24"/30"/36"W. INTEGRATED ALL REFRIGERATOR

DESCRIPTION	FDREIC7240	FDREIC7300	FDREIC7360
Overall Width	23-7/8 (60.8 cm)	29-7/8" (76.0 cm)	35-7/8" (91.2 cm)
Overall Height (from bottom)	83-1/2" (212.1 cm) min. to 84-1/2" (214.6 cm) max.		
Overall Depth from Rear	To front edge of side trim: 22" (56.0 cm) To front door: 24" (61.0 cm)		
Cutout Width	24" (61.0 cm)	30" (76.2 cm)	36" (91.4 cm)
Cutout Height	84" (213.4 cm) min. to 84-1/16" (213.5 cm) max.		
Cutout Depth	24" (61.0 cm) plus panel thickness		
Electrical Requirements	115 volt, 60 Hz, 15 amp dedicated circuit; 3-wire cord with grounded 9 ft. 3-prong plug attached to product		
Maximum Amp Usage	9.9 amps		
Inlet Water Requirements	1/4" copper tubing inlet waterline; minimum 20 psi; maximum 120 psi		
Maximum Panel Weight	75 lbs. (34 kg)		
Overall Interior Capacity	13.0 cu. ft. (368.1 L)	16.9 cu. ft. (478.6 L)	21.9 cu. ft. (320.1 L)
Approximate Shipping Weight	335 lbs. (152.0 kg)	386 lbs. (175.1 kg)	417 lbs. (189.1 kg)

Please do not prepare installation from brochure data only. See installation instructions for important clearance/installation information.



NEW 24"/30"/36"W. INTEGRATED ALL REFRIGERATOR

FDREIC

INSTALLATION CUTOUT FEATURES: PANEL-READY

A Minimum cutout height
84" (213.4 cm)

Cutout width

36" model: 36" (91.4 cm)
30" model: 30" (76.2 cm)
24" model: 24" (61.0 cm)

Minimum cutout depth

24" (61.0 cm) + panel thickness for flush installation

Area to be left clear for the anti-tipping brackets

5" (12.7 cm) for both right and left sides

B Appliance height
83-1/2" (212.0 cm) + 1" (2.5 cm)

A

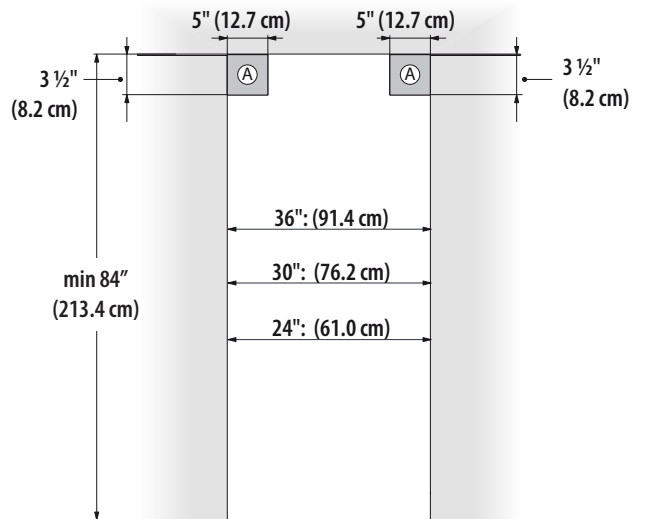

WIDTH OF APPLIANCE BODY

36" model: 34-7/8" (88.5 cm)

30" model: 28-7/8" (73.5 cm)

24" model: 23" (58.5 cm)

24" (61.0 cm)

22" (56.0 cm)

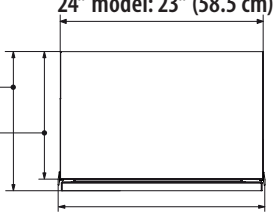

36" model: 35-7/8" (91.2 cm)

30" model: 29-7/8" (76.0 cm)

24" model: 23-7/8" (60.8 cm)

Width of appliance with mounting brackets installed
(effective width)

B

83 1/2" (212.0 cm)
+ 1" (2.5 cm)

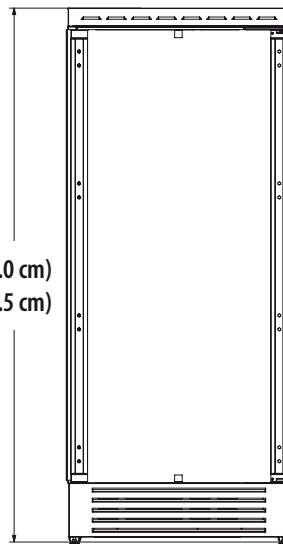

24" 61.0 cm
22" (56.0 cm)

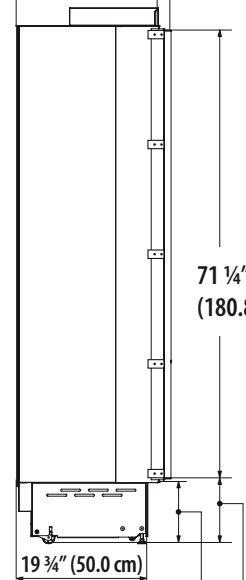

71 1/4" (180.8 cm)

9 1/8" (23.1 cm) + 1" (2.5 cm)

9 1/4" (23.3 cm) + 1" (2.5 cm)



NEW 24"/30"/36"W. INTEGRATED ALL REFRIGERATOR

Viking 7 Series – FDREIC

WIDTH	DOOR/DRAWER WIDTH A
36"	35-3/4" (90.8 cm)
30"	29-3/4" (75.6 cm)
24"	23-3/4" (60.4 cm)

Panels with thickness ranging between 3/4" (1.9 cm) and 1-1/8" (2.8 cm). Door panels with max weight of 75 lbs. (34 kg).

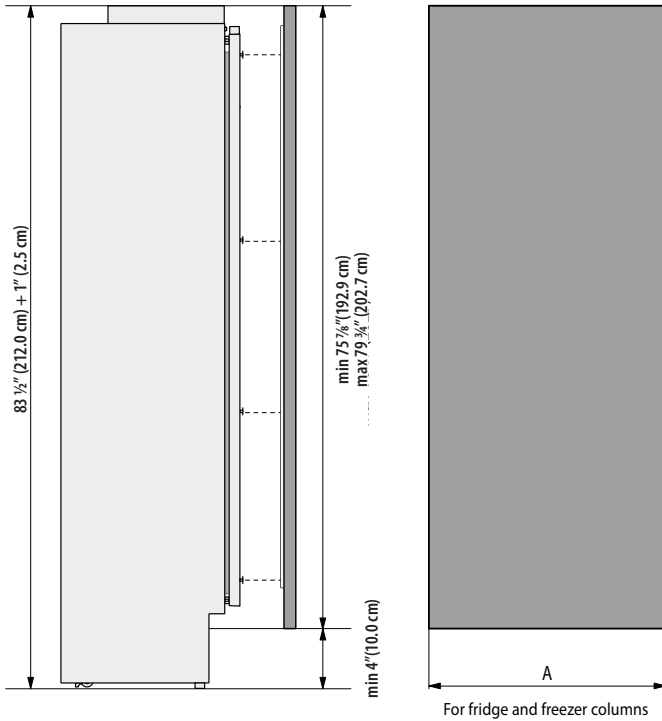

CUTOUT DIMENSIONS FOR COMBINED INSTALLATION

		A			
		18"	24"	30"	36"
B	18"	36" (91.4 cm)	42" (106.7 cm)	48" (122.0 cm)	54" (137.2 cm)
	24"	42" (106.7 cm)	48" (122.0 cm)	54" (137.2 cm)	60" (152.0 cm)
	30"	48" (122.0 cm)	54" (137.2 cm)	60" (152.0 cm)	66" (167.6 cm)
	36"	54" (137.2 cm)	60" (152.4 cm)	66" (167.6 cm)	72" (182.9 cm)

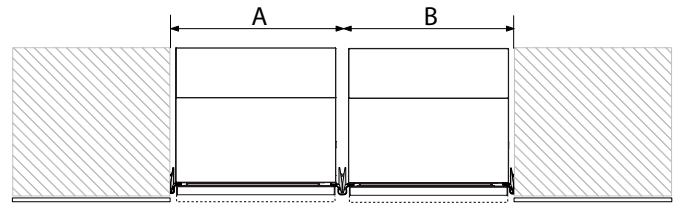

DOOR-SWING CLEARANCE

Door Swing Clearance

- 36" model: 58 5/8" (148.9 cm)
- 30" model: 52 5/8" (133.8 cm)
- 24" model: 46 3/4" (118.7 cm)

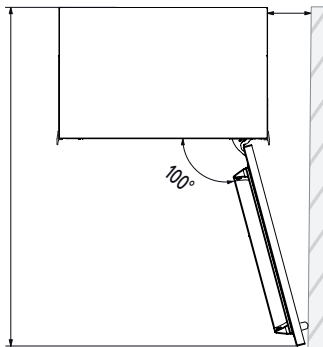

Minimum distance from the wall (hinge side)

- 36" model: 6 1/4" (15.9 cm)
- 30" model: 5 1/4" (13.2 cm)
- 24" model: 4 1/4" (10.8 cm)



VIKING RANGE, LLC 111 FRONT STREET GREENWOOD, MISSISSIPPI 38930 USA

For detailed product information, model numbers, or to request a quote call 1-888-845-4641 or visit vikingrange.com

© 2025 Viking Range, LLC All rights reserved. Specifications subject to change without notice.