

BLODGETT® **BLODGETT**® **BLODGETT**® **BLODGETT**®

BLODGETT® **BLODGETT**® **BLODGETT**®

BLODGETT® **BLODGETT**® **BLODGETT**® **BLODGETT**®

BLODGETT®

**CNVX-14G AND CNVX-14E
GAS & ELECTRIC CONVECTION OVENS
INSTALLATION - OPERATION - MAINTENANCE**



BLODGETT OVEN COMPANY

www.blodgett.com

42 Allen Martin Drive, Essex Junction, VT 05452 USA Telephone: (802) 658-6600 Fax: (802) 864-0183

PN 100561 Rev D (2/24)

© 2021 - G.S. Blodgett Corporation

Your Service Agency's Address:

Model

Serial number

Oven installed by

Installation checked by

TABLE OF CONTENTS

IMPORTANT

WARNING: Improper installation, adjustment, alternation, service or maintenance can cause property damage, injury or death. Read the installation, operation and maintenance instructions thoroughly before installing or servicing this equipment.

INSTRUCTIONS TO BE FOLLOWED IN THE EVENT THE USER SMELLS GAS MUST BE POSTED IN A PROMINENT LOCATION. This information may be obtained by contacting your local gas supplier.

FOR YOUR SAFETY

Do not store or use gasoline or other flammable vapors or liquids in the vicinity of this or any other appliance.

The information contained in this manual is important for the proper installation, use, and maintenance of this oven. Adherence to these procedures and instructions will result in satisfactory baking results and long, trouble free service. Please read this manual carefully and retain it for future reference.

ERRORS: Descriptive, typographic or pictorial errors are subject to correction. Specifications are subject to change without notice.

INSTALLATION

Owner's Responsibilities	2
Utility Connections - Standards and Codes.....	3
Oven Location and Ventilation.....	4
Leg Attachment.....	5
Caster Attachment.....	6
Stacking.....	7
Plumbing Connections.....	8
Electrical Connections.....	9
Gas Connection.....	10
Gas Hose Restraint.....	12
Adjustments.....	13
Final Check Lists	14

OPERATION

Safety Information for Gas Units	15
Power Switches	16
Standard Controls.....	17
SmartTouch 2 Touchscreen Control	21
One Touch Touchscreen Control	33

MAINTENANCE

Spray Bottle Operating Procedure.....	51
Cleaning and Preventive Maintenance.....	52



Installation

Owner's Responsibilities

INSTALLATION RESPONSIBILITIES PRIOR TO SERVICE STARTUP INSPECTION

You are entitled to a free start-up inspection service by our factory ASAP. Before a factory representative arrives to perform a startup procedure, the owner must already have satisfied the following requirements.

1. Oven(s) are uncrated, stacked (if applies) and put in place.

NOTE: Please refer to Leg Attachment and Stacking.

Maximum shelf loading - 60 lbs (27.3 Kg)

PLUMBING SPECIFICATIONS	
WATER	
Water pressure	40 PSI minimum 50 PSI maximum
Water connection	3/4" garden hose for spray hose - Cold water only
Minimum requirements	TDS: 40-125 ppm Hardness: 35-180 ppm Chlorides: <25 ppm Silica: <13 ppm Chlorine: <0.2 ppm Chloramine: <0.2 ppm pH: 7.0-8.5
DRAINAGE	
Drain type	Atmospheric Vented Drain
Drain connection	2.00" (50.8mm) Copper
Maximum water drain temperature	140°F (60°C)

ELECTRICAL RATINGS - CNVX-14G/AA					
TYPE OF GAS	GAS INPUT	VOLTAGE	PHASE	AMPS	MOTOR
Natural	65,000 BTU/Hr	115	1	12	3/4 HP 208-240VAC, 3 phase, 50/60 Hz
		208-240	1	6	
Propane	65,000 BTU/Hr	115	1	12	3/4 HP 208-240VAC, 3 phase, 50/60 Hz
		208-240	1	6	

3/4" NPT connector for all U.S. and Canadian installations

RATINGS - CNVX-14E/AA							
VOLTAGE	HZ	KW	PHASE	MAX LOAD (AMPS)			MOTOR
				L1	L2	L2	
208	60	19	3	53	53	50	3/4 HP 208-240VAC, 50/60 Hz
240	60	19	3	46	46	43	3/4 HP 208-240VAC, 50/60 Hz
480	60	19	3	23	23	21	3/4 HP 208-240VAC, 50/60 Hz

Utility Connections - Standards and Codes

THE INSTALLATION INSTRUCTIONS CONTAINED HEREIN ARE FOR THE USE OF QUALIFIED INSTALLATION AND SERVICE PERSONNEL ONLY. INSTALLATION OR SERVICE BY OTHER THAN QUALIFIED PERSONNEL MAY RESULT IN DAMAGE TO THE OVEN AND/OR INJURY TO THE OPERATOR.

Qualified installation personnel are individuals, a firm, a corporation, or a company which either in person or through a representative are engaged in, and are responsible for:

- The installation or replacement of gas piping. The connection, installation, repair or servicing of equipment.
- The installation of electrical wiring from the electric meter, main control box or service outlet to the electric appliance.

Qualified installation personnel must be experienced in such work, be familiar with all precautions required and have complied with all requirements of state or local authorities having jurisdiction.

U.S. and Canadian Installations

Installation must conform with local codes, or in the absence of local codes, with the National Fuel Gas Code, NFPA54/ANSI Z223.1-Latest Edition, the Natural Gas Installation Code CAN/CGA-B149.1 or the Propane Installation Code, CAN/CGA-B149.2 as applicable.

Reference: National Electrical Code, ANSI/NFPA 70-Latest Edition and/or Canadian Electrical Code CSA C22.1 as applicable.

This equipment is to be installed in compliance with the Basic Plumbing Code of the Building Officials and Code Administrators International Inc. (BOCA) and the Food Service Sanitation Manual of the Food and Drug Administration (FDA).

Appliance is to be installed with backflow prevention in accordance with applicable federal, province and local codes.

General Export Installations

Installation must conform with Local and National installation standards. Local installation codes and/or requirements may vary. If you have any questions regarding the proper installation and/or operation of your appliance, please contact your local distributor. If you do not have a local distributor, please call Blodgett Combi at 0011-802-658-6600.





Installation

Oven Location and Ventilation

OVEN LOCATION

The well planned and proper placement of your oven will result in long term operator convenience and satisfactory performance.

Certain minimum clearances must be maintained between the oven and any combustible or non-combustible construction. See the table below.

In addition, the following clearances are recommended for servicing.

- Oven body sides - 12" (30cm)
- Oven body back - 12" (30cm)

NOTE: On gas models, routine servicing can usually be accomplished within the limited movement provided by the gas hose restraint. If the oven needs to be moved further from the wall, the gas must first be turned off and disconnected from the oven before removing the restraint. Reconnect the restraint after the oven has been returned to its normal position.

Left Side Heat Shield

Heat sources should not be near the air vents located on the left hand side of the gas appliance.

OVEN MODEL	MINIMUM REQUIRED CLEARANCES		
	Right Side	Left Side	Back
CNVX-14G	1" (25.4mm)	6" (152.4mm)	6" (152.4mm)
CNVX-14E	2" (50.8mm)	2" (50.8mm)	3" (76.2mm)

- Do not place strong sources of heat such as open flame ranges, griddles, or charbroilers near the oven. If such an instance exists, it is highly recommended to purchase a heat shield, available from Blodgett.
- Note that if temperatures are too high, a safety shutdown may occur.
- Failure to comply may invalidate the oven warranty.

VENTILATION

The necessity for a properly designed and installed ventilation system cannot be over emphasized. The ventilation system will allow the unit to function properly while removing unwanted vapors and products of combustion from the operating area.

The appliance must be vented with a properly designed mechanically driven exhaust hood. The hood should be sized to completely cover the equipment plus an overhang of at least 6" (15 cm) on all sides not adjacent to a wall. The capacity of the hood should be sized appropriately and provisions made for adequate makeup air.



WARNING!!

Failure to properly vent the oven can be hazardous to the health of the operator; and will result in operational problems, unsatisfactory baking, and possible damage to the equipment. Damage sustained as a direct result of improper ventilation will not be covered by the Manufacturer's warranty.

When installed in the Commonwealth of Massachusetts, this appliance must be interlocked with the hood exhaust system so that the appliance may be operated only when the hood exhaust system is running.

U.S. and Canadian Installations

Refer to your local ventilation codes. In the absence of local codes, refer to the National ventilation code titled, "Standard for the Installation of Equipment for the Removal of Smoke and Grease Laden Vapors from Commercial Cooking Equipment", NFPA-96- Latest Edition.

General Export Installations

Installation must conform with Local and National installation standards. Local installation codes and/or requirements may vary. If you have any questions regarding the proper installation and/or operation of your unit, please contact your local distributor. If you do not have a local distributor, please call Blodgett Combi at 0011-802-658-6600.

Leg Attachment

LEG OPTIONS

Legs are available in 4" (101mm), 6" (152mm) or 25" (635mm) lengths or low profile casters.

- The 4" (101mm) legs may be used when mounting on a counter.
- The 6" (152.4mm) legs are used on the lower section of a double stacked appliance.
- The 25" (635mm) legs are used for a single appliance located on the floor.

NOTE: For safety reasons, casters must not be used with the 25" (635mm) legs.

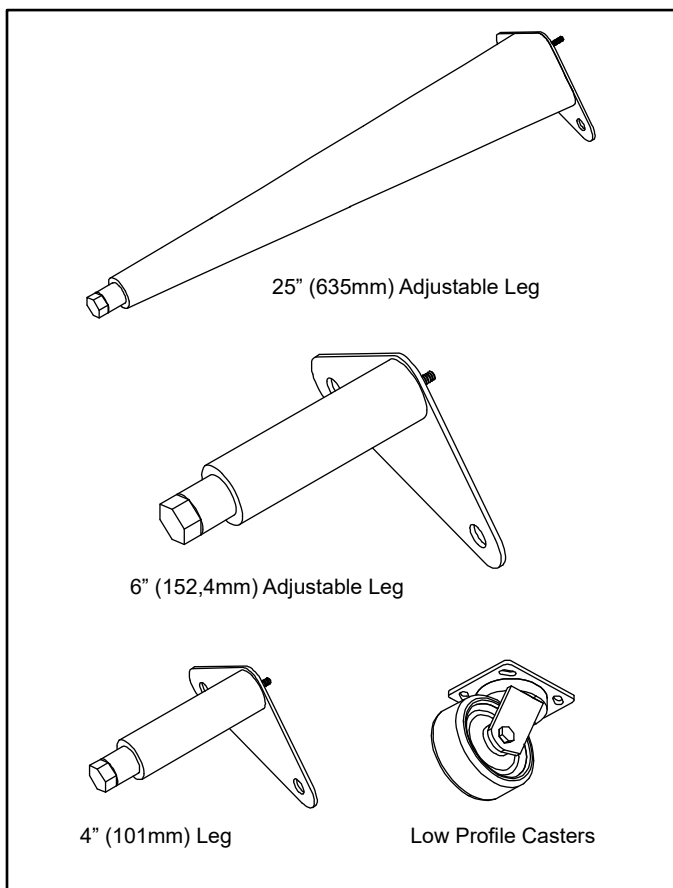

Figure 1

ATTACHMENT

1. Align the threaded stud on one of the front legs to the bolt hole located in the bottom corner of the appliance. Turn the leg clockwise and tighten to the nearest full turn.
2. Align the leg plate holes with the bolt holes. Secure with the two 1/2" bolts provided.
3. Repeat the above steps with the other front leg. If low profile casters are used, install them with the locking casters in the front of the oven. The rear casters do not lock. **Ensure that the locks are set on the front casters.**
4. Tip the oven up on the newly installed front legs. If casters are used, check that the locks are set on the front casters. Repeat the above steps for the rear legs.
5. Level the oven by screwing the adjustable feet in or out as necessary.

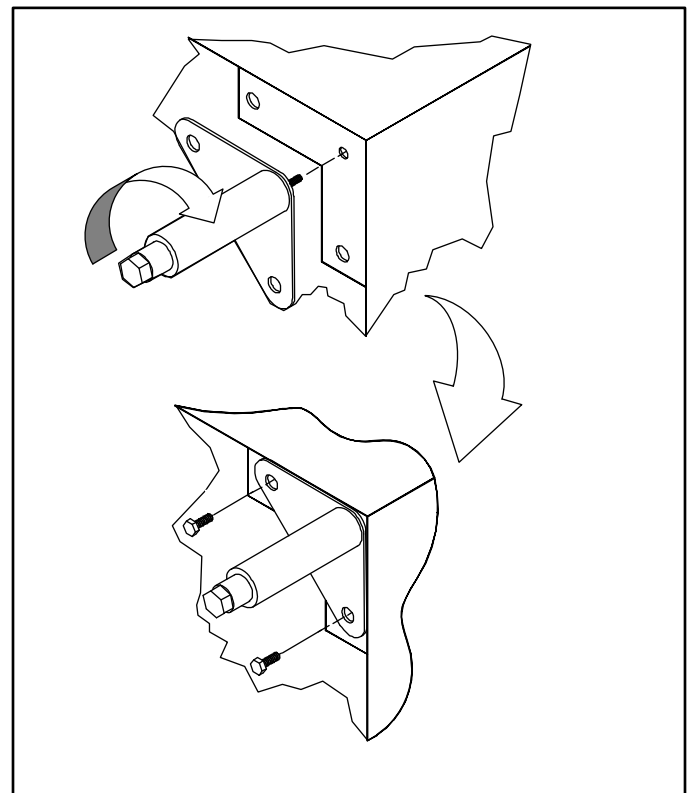

Figure 2



Installation

Caster Attachment

1. Place a level on the floor where the casters are to rest.
2. Place shims under the low side until it is level.
3. Mount the shims between the casters and the oven as follows:
 - a. Align the shims and caster holes with the bolt holes.
 - b. Secure with the 1/2" bolts provided.

NOTE: Install them with the locking casters in the front of the oven. The rear casters do not lock. Ensure that the locks are set on the front casters.

4. Tip the oven up on the newly installed casters.

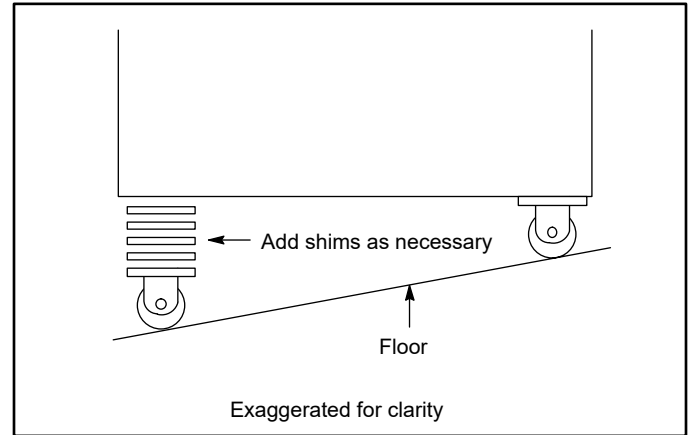

Figure 3

Stacking

WARNING!!

Stacking should be performed by qualified installation personnel only. The ovens are heavy. Take care to use proper tools and techniques when lifting and stacking units.

1. Attach the legs or casters to the bottom oven.
2. Place the top oven on the bottom oven. Be sure all four sides are flush.
3. Remove left side oven panels.
4. Bolt the two ovens together from underneath into the two threaded nut retainers.
5. **GAS APPLIANCES ONLY:** Attach the flue vents and gas manifold as shown.

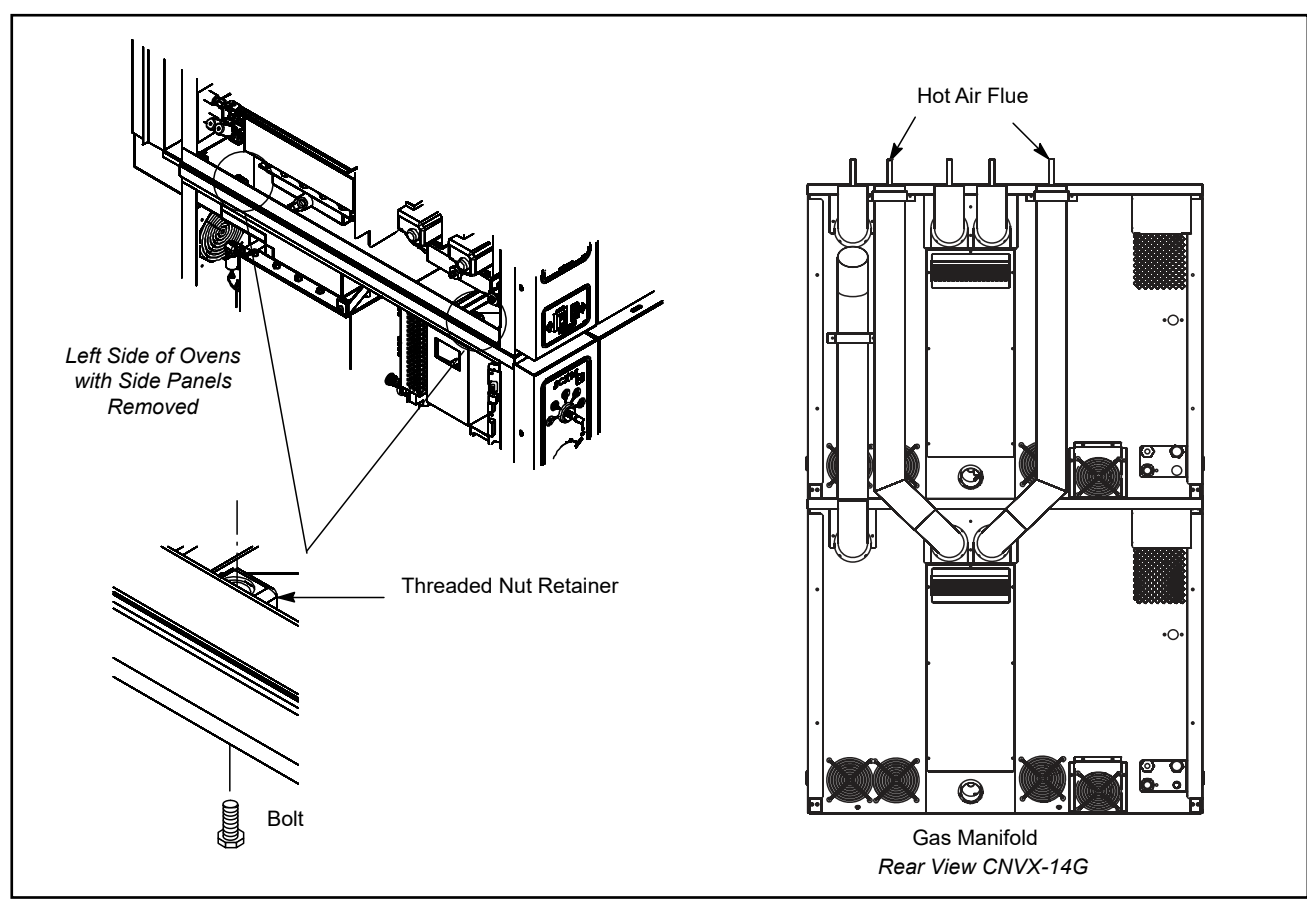

Figure 4



Installation

Plumbing Connections

WATER CONNECTION

Connect the appliance to quality water via a pressure hose with 3/4" GHT (19mm) couplings. See below for connections. A shut off valve is to be provided adjacent to the oven.



Operating the appliance without the water regulator installed will invalidate your warranty.

This product must be installed by a licensed Plumber or Gas Fitter when installed within the Commonwealth of Massachusetts.

DRAIN CONNECTION

The drain should be run to an open floor drain avoiding flexible hose that could sag and allow trapped water to accumulate. The customer must supply the piping from the oven to the drain.

NOTE: The drain piping must consist of temperature resistant material, greater than 160°F, and be of adequate diameter not to cause flow restriction. Improper materials may deform and cause restrictions, thus affecting performance.



WARNING!!

Connection must be carried out by a licensed plumber, to an open or closed drain. The drain must never end directly beneath the equipment. The drain should not be located on the same side the equipment controls are located.

Specific water/drain connection for City of Los Angeles

1. Each drain line from the appliance shall be routed without dips or sags to terminate above the flood level rim of an approved indirect waste receptor.
2. The appliance shall be installed in accordance with the manufacturer's printed instructions and the LAPC and LAMC, 1999 editions.
3. A backflow protection device may be required by local codes. If so, install on the potable water system directly ahead of the appliance. The backflow protection device shall be any of the following: an approved pressure type vacuum breaker installed at least 12" above the highest point of use, a double check valve backflow preventer or a reduced pressure principal backflow preventer.

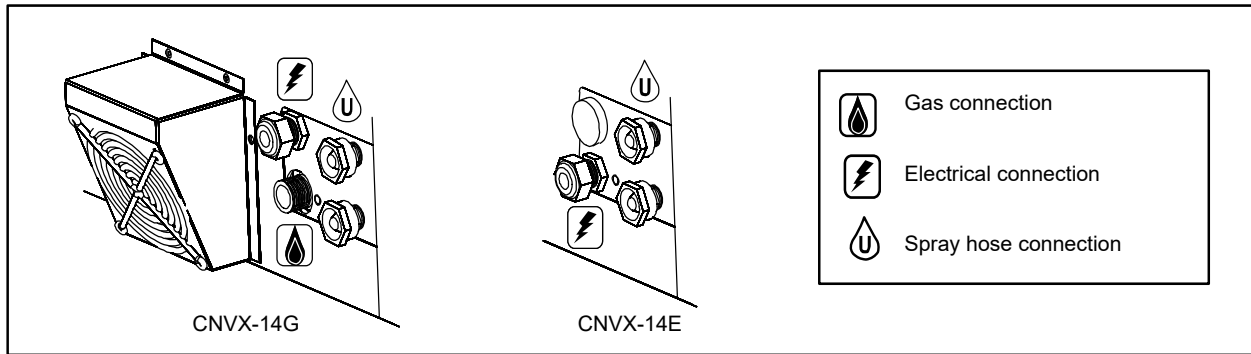

Figure 5

ELECTRICAL CONNECTION

All Models

NOTE: Electrical connections must be performed by a qualified installer only.

Before making any electrical connections to these appliances, check that the power supply is adequate for the voltage, amperage, and phase requirements stated on the rating name plate mounted on the appliance.

The circuit breaker that is used to provide power to this appliance must have a minimum of .076" (3mm) contact spacing. The circuit breaker must meet all Local and National installation standards.

All appliances must be installed in accordance with Local or National Electrical codes.

This appliance uses a variable frequency drive, which can be known to product high frequency electrical noise. In some cases units must be hard wired. This avoids false positives on ground fault devices susceptible to errors from electrical noise. All installations must comply with local and national codes.

A wiring schematic is located on the inside of the removable side panel.

NOTE: Disconnect the power supply to the appliance before servicing.



WARNING!!

Improper installation may invalidate your warranty.

Electric Models

A strain relief for the power supply cord is provided. The installer must supply a cord that meets all Local and National installation standards.

Gas Models

U.S. and Canadian Installations

A power cord (115V units only) is supplied with a plug attached. Plug the power cord into the desired receptacle.

This oven model uses a variable frequency inverter drive. Appliances that use variable frequency inverter drives produce high frequency noise and require filters and shielded motor cabling. This causes higher leakage current toward Earth Ground. Especially, at the moment of switching ON this can cause an inadvertent trip of the appliance's ground fault interrupter (GFCI). Some GFCIs are more sensitive than others. Blodgett has qualified the Pass and Seymour brand, part number 2095, 20 A, 125 VAC, 60 Hz, specification grade GFCI duplex receptacle as being immune to the variable frequency inverter drive's noise. Blodgett recommends using this specific GFCI for this model oven.



WARNING!!

If the supply cord is damaged, it must be replaced by a special cord or assembly available from the manufacturer or its service agent.



Installation

Gas Connection

GAS PIPING

A properly sized gas supply system is essential for maximum oven performance. Piping should be sized to provide a supply of gas sufficient to meet the maximum demand of all appliances on the line without loss of pressure at the equipment.

Example:

NOTE: BTU values in the following example are for natural gas.

You purchase a CNVX-14G to add to your existing cook line.

1. Add the BTU rating of your current appliances.

Pitco Fryer	120,000 BTU
6 Burner Range	60,000 BTU
Deck Oven	50,000 BTU
Total	230,000 BTU

2. Add the BTU rating of the new oven to the total.

Previous Total	230,000 BTU
CNVX-14G	65,000 BTU
New Total	295,000 BTU

3. Measure the distance from the gas meter to the cook line. This is the pipe length. Let's say the pipe length is 40' (12.2 m) and the pipe size is 1" (2.54 cm).

4. Use the appropriate table to determine the total capacity of your current gas piping.

The total capacity for this example is 295,000 BTU. Since the total required gas pressure, 295,000 BTU is less than 375,000 BTU, the current gas piping will not have to be increased.

NOTE: The BTU capacities given in the tables are for straight pipe lengths only. Any elbows or other fittings will decrease pipe capacities. Contact your local gas supplier if you have any questions.

Maximum Capacity of Iron Pipe in Cubic Feet of Natural Gas Per Hour

(Pressure drop of 0.5 Inch W.C.)

PIPE LENGTH (FT)	NOMINAL SIZE, INCHES				
	3/4"	1"	1-1/4"	1-1/2"	2"
10	360	680	1400	2100	3950
20	250	465	950	1460	2750
30	200	375	770	1180	2200
40	170	320	660	990	1900
50	151	285	580	900	1680
60	138	260	530	810	1520
70	125	240	490	750	1400
80	118	220	460	690	1300
90	110	205	430	650	1220
100	103	195	400	620	1150

From the National Fuel Gas Code Part 10 Table 10-2

Maximum Capacity of Pipe in Thousands of BTU/hr of Undiluted L.P. Gas at 11" W.C.

(Pressure drop of 0.5 Inch W.C.)

PIPE LENGTH (FT)	OUTSIDE DIAMETER, INCHES		
	3/4"	1"	1-1/2"
10	608	1146	3525
20	418	788	2423
30	336	632	1946
40	287	541	1665
50	255	480	1476
60	231	435	1337
70	215	404	1241
80	198	372	1144
90	187	351	1079
100	175	330	1014

From the National Fuel Gas Code Part 10 Table 10-15

PRESSURE REGULATION AND TESTING

The gas pressure to the appliance must be rated for each appliance while the burners are on. A sufficient gas pressure must be present at the inlet to satisfy these conditions. Refer to the table below for correct gas pressure.

Each appliance has been adjusted at the factory to operate with the type of gas specified on the rating plate.

Each oven is supplied with a regulator to maintain the proper gas pressure. The regulator is essential to the proper operation of the oven and should not be removed.

DO NOT INSTALL AN ADDITIONAL REGULATOR WHERE THE UNIT CONNECTS TO THE GAS SUPPLY UNLESS THE INLET PRESSURE IS GREATER THAN 14" W.C. (1/2 PSI) (37mbar).

The oven and its individual shutoff valve must be disconnected from the gas supply piping system during any pressure testing of that system at test pressures in excess of 1/2 psig (3.45kPa).

The oven must be isolated from the gas supply piping system by closing its individual manual shutoff valve during any pressure testing of the gas piping system at test pressures equal or less than 1/2 psig (3.45kPa).

Prior to connecting the appliance, gas lines should be thoroughly purged of all metal filings, shavings, pipe dope, and other debris. After connection, the appliance must be checked for correct gas pressure.

U.S. and Canadian Installations

Installation must conform with local codes, or in the absence of local codes, with the National Fuel Gas Code, NFPA54/ANSI Z223.1-Latest Edition, the Natural Gas Installation Code CAN/CGA-B149.1 or the Propane Installation Code, CAN/CGA-B149.2 as applicable.

General Export Installations

Installation must conform with Local and National installation standards. Local installation codes and/or requirements may vary. If you have any questions regarding the proper installation and/or operation of your appliance, please contact your local distributor. If you do not have a local distributor, please call Blodgett Combi at 0011-802-658-6600.

GAS PRESSURE - CNVX-14G					
Gas Type	Inlet Pressure	Orifice Size at Sea Level		Manifold Pressure	
		Hot Air	Steam	Hot Air	Steam
Natural	7-14" W.C.	.0531" dia	—	3.5" W.C.	—
Propane	12-14" W.C.	.032" dia	—	10" W.C.	—



Installation

Gas Hose Restraint

If the appliance is mounted on casters, a commercial flexible connector with a minimum of 3/4" (1.9 cm) inside diameter must be used along with a quick connect device.

A restraint must be used to limit the movement of the appliance so that no strain is placed upon the flexible connector. The restraint should be fastened to the base frame of the oven as close to the flexible connector as possible. It should be short enough to prevent any strain on the connector. With the restraint fully stretched the connector should be easy to install and quick connect.

The restraint (ie: heavy gauge cable) should be attached without damaging the building. DO NOT use the gas piping or electrical conduit for the attachment of the permanent end of the restraint! Use anchor bolts in concrete or cement block. On wooden walls, drive hi test wood lag screws into the studs of the wall.



WARNING!!

If the restraint is disconnected for any reason it must be reconnected when the appliance is returned to its original position.

U.S. and Canadian installations

The connector must comply with the Standard for Connectors for Movable Gas Appliances, ANSI Z21.69 or Connectors For Moveable Gas Appliances CAN/CGA-6.16 and a quick disconnect device that complies with the Standard for Quick-Disconnect Devices for Use With Gas Fuel, ANSI Z21.41 or Quick Disconnect For Use With Gas Fuel CAN 1-6.9. Adequate means must be provided to limit the movement of the appliance without depending on the connection and the quick disconnect device or its associated piping.

A drip leg must be used at each appliance. Refer to NFPA54/ANSI Z223.1 - Latest Edition (National Fuel Gas Code) for proper drip leg installation.

General export installations

Installation must conform with Local and National installation standards. Local installation codes and/or requirements may vary. If you have any questions regarding the proper installation and/or operation of your appliance, please contact your local distributor. If you do not have a local distributor, please call Blodgett Combi at 0011-802-658-6600.

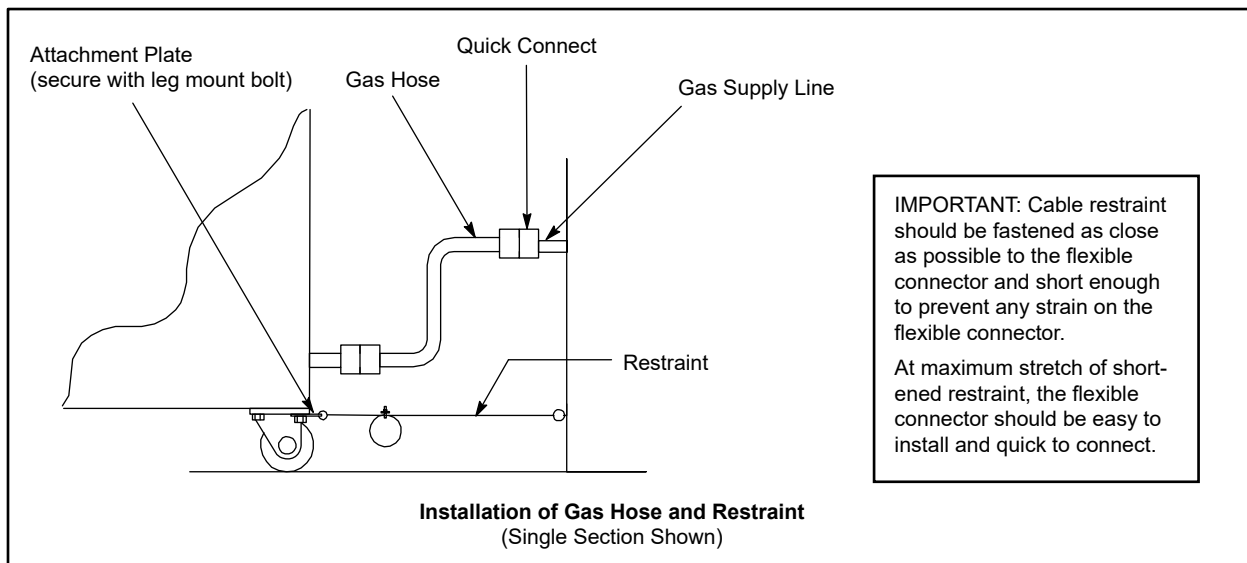

Figure 6

Adjustments

Before applying power to the appliance for the first time, check for the following conditions:

- All electrical safety provisions have been adhered to and the electrical connections are correct.
- Water is connected, turned on and all of the connections are water tight.
- The pan holders are inserted into the oven cavity.
- Cardboard has been removed from oven cavity.
- Gas has been turned on, if gas unit.

DOOR ADJUSTMENT

The door catch may be adjusted in and out using the following procedure:

1. Flip the rubber boot on the catch towards you.
2. Loosen the locknut to make adjustment.
3. Rotate the catch clockwise or counter clockwise to get proper adjustment.
4. Retighten locknut, assuring the catch is vertical.
5. Flip the rubber boot back into position.

The hinges can also be adjusted as follows:

1. Loosen the two 1/4-20 bolts on the top of the hinge plate and the two bolts on the bottom hinge plate.
2. Apply pressure to the door on the corners to get the proper seal. While pushing, tighten the bolts in place.

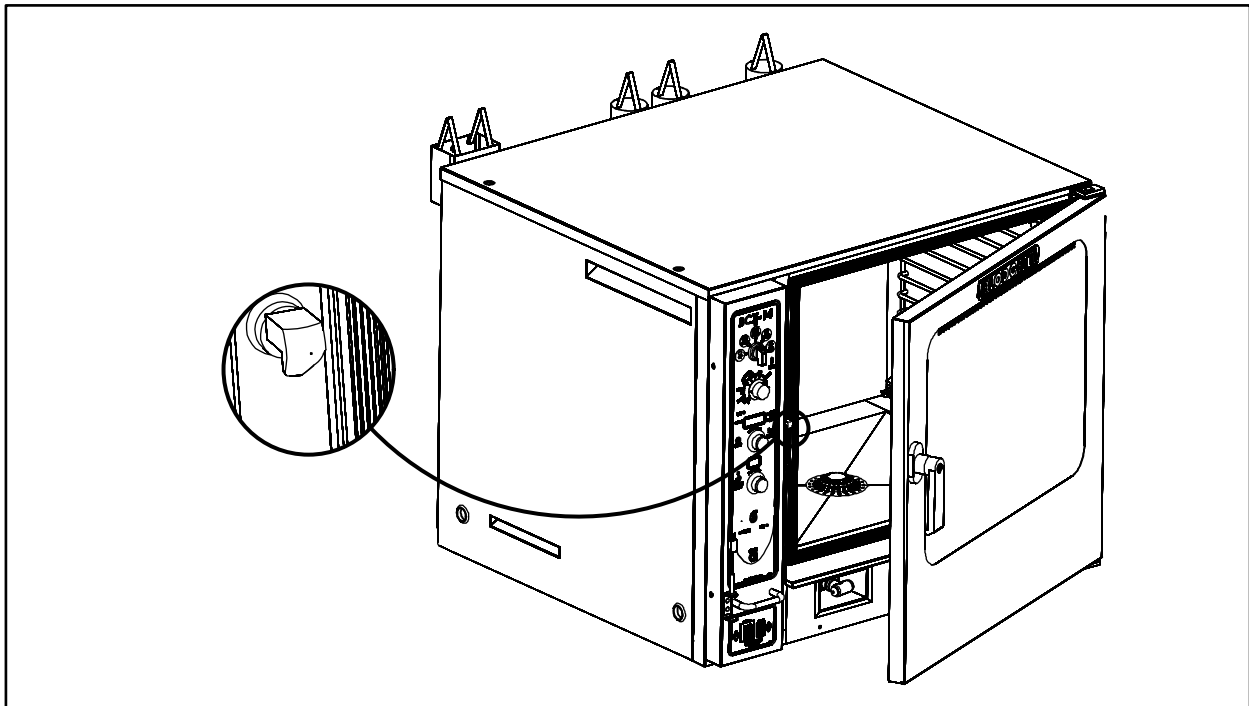

Figure 7



Installation

Final Check Lists



WARNING!!

Final check list must be performed by a qualified installer only.

ELECTRICAL CONTROL COMPARTMENT

- Voltage to appliance matches rating plate

PLUMBING FINAL CHECK

- Incoming water pressure within appliance specification.
- Atmospheric vented drain in place.
- Water feed line intact without leaks.
- Ensure proper clearance as detailed.

OVEN OPERATIONAL TESTS

NOTE: Checks to be made by customer or authorized service agent.

Cool Down Mode

- Check that the fan runs with the door open.

Cook Mode

Set thermostat to 400°F (204°C) and verify:

- The oven is preheating and shows the actual cavity temperature rising.
- Heat demand shuts off at 400°F (204°C) and oven maintains 400°F (204°C).
- Fan shuts off with door open.

Lights

- Press switch to ensure lights come on.

Cavity Vent

- Press the vent key to ensure that the vent opens and closes.

Fan Speed

- Ensure all fan speeds work on the preheated oven using the fan key and knob.

Safety Information for Gas Units

The information contained in this section is provided for the use of qualified operating personnel. Qualified operating personnel are those who have carefully read the information contained in this manual, are familiar with the functions of the oven and/or have had previous experience with the operation of the equipment described. Adherence to the procedures recommended herein will assure the achievement of optimum performance and long, trouble-free service.

Please take the time to read the following safety and operating instructions. They are the key to the successful operation of your Blodgett oven.



SAFETY TIPS

For your safety read before operating

What to do if you smell gas:

- What to do if you smell gas:
- DO NOT try to light any appliance.
- DO NOT touch any electrical switches.
- Use an exterior phone to call your gas supplier immediately.
- If you cannot reach your gas supplier, call the fire department.

What to do in the event of a power failure:

- Turn all switches to off.
- DO NOT attempt to operate the appliance until the power is restored.

NOTE: In the event of a shut-down of any kind, allow a five (5) minute shut off period before attempting to restart the oven.

General safety tips:

- DO NOT use tools to turn off the gas control. If the gas cannot be turned off manually do not try to repair it. Call a qualified service technician.
- If the oven needs to be moved for any reason, the gas must be turned off and disconnected from the appliance before removing the restraint cable. Reconnect the restraint after the oven has been returned to its original location.
- DO NOT remove the control panel cover unless the oven is unplugged.



Operation

Power Switches

CONTROLS IDENTIFICATION

1. HEAT CONTROL SWITCH

Gas Ovens - Used to turn gas on or off.

Electric Ovens - Used to turn power to the elements on or off.

2. CIRCUIT BREAKER - Used to turn power to the unit on or off. This switch should always stay ON.

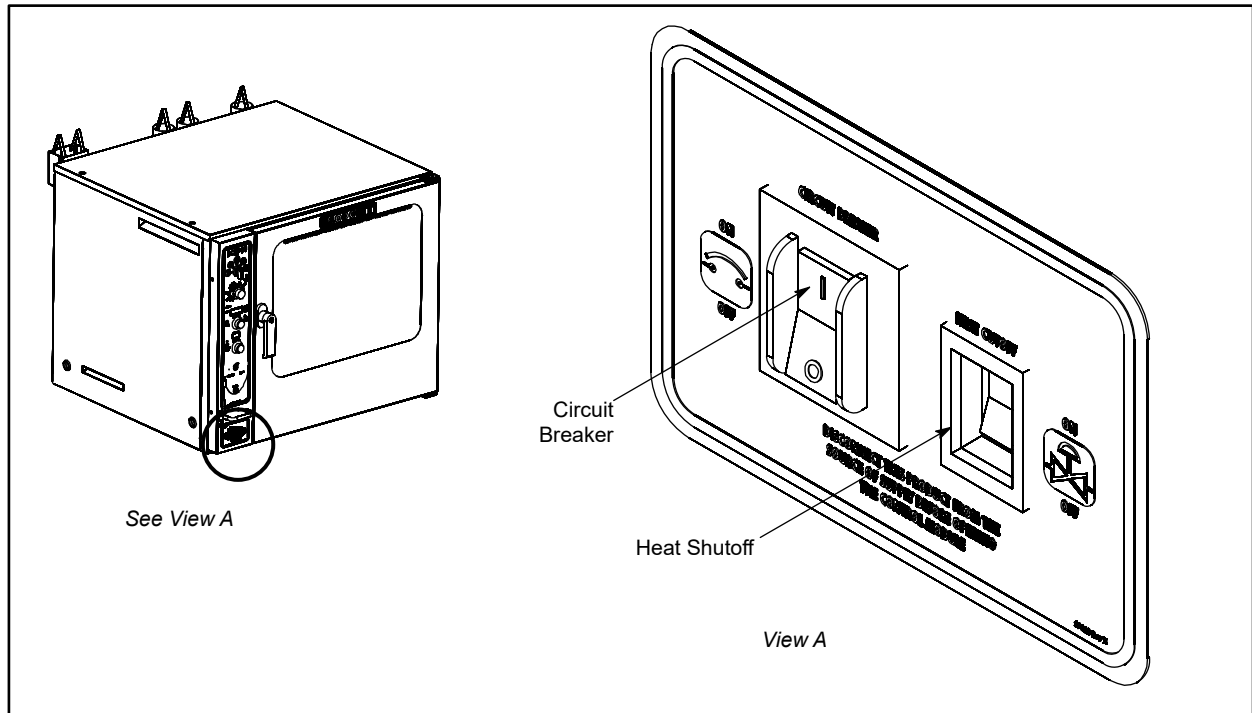

Figure 8

Standard Controls

CONTROLS IDENTIFICATION

1. POWER KEY - used to place control in and out of standby mode
2. DISPLAY - displays time, temperature, humidity and other information related to oven function and/or programming
3. DISPLAY KEYS - context sensitive keys used to interact with the display
4. TEMP KEY - used to set or change the bake temperature
5. CONTROL KNOB - used to change values for time, temperature, humidity, etc.
6. TIME KEY - used to set or change the cook time
7. START KEY - press to start the cook cycle
8. VENT KEY - press to manually open and close the vent
9. +1 MINUTE KEY - press at any time to add additional minute to the cook time
10. PROBE KEY - press to use core probe cooking
11. FAN KEY - used to select fan speed
12. HYDRO BURST KEY - press to add a burst of humidity at any time during the cook cycle
13. LIGHTS KEY - press to turn the oven lights on and off
14. RECIPES KEY - press to access product programs or to add/edit a product
15. COOL DOWN KEY - initiates oven cool down cycle
16. TOOLS KEY - press to enter manager programming
17. USB PORT AND COVER - used to transfer recipes to and from the control
18. HEAT CUTOFF - used to turn heat source off
19. CIRCUIT BREAKER - Used to turn power to the unit on or off
20. CORE PROBE CONNECTION - plug core temperature probe in here when using probe cooking

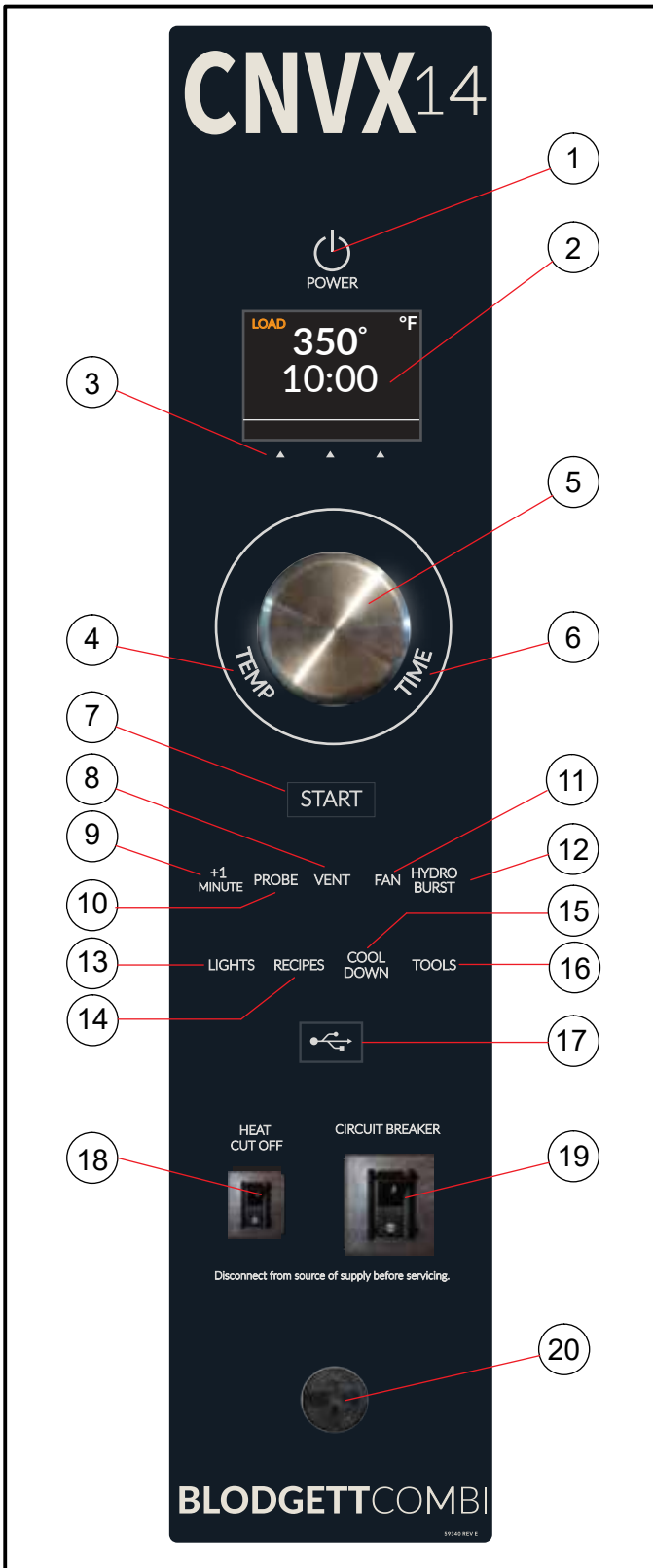



Figure 9



Operation

Standard Controls

OVEN STARTUP

1. Be sure the circuit breaker and heat cutoff switches are in the ON position. The display flashes PRESS  POWER KEY TO TURN ON.
2. Press the POWER KEY (1). The display reads “To begin press time/temp/humidity key”. Each key illuminates in succession. Press any key or rotate the knob.
3. The display reads PREHEAT and the oven heats to the last manual set temperature.

The display reads LOAD, the start key flashes and the alarm beeps when the oven is at temperature and ready to bake.

MANUAL COOKING

1. Press the TIME KEY (6). Rotate the CONTROL KNOB (5) to enter the desired cook time. Press any key to accept the value.

*NOTE: Turn the knob slowly to adjust in seconds.
Turn the knob quickly to adjust in minutes.*

2. Press the TEMP KEY (4). Rotate the CONTROL KNOB (5) to enter the desired cook temperature. Press any key to accept the value. The oven preheats to the new set temperature.
3. When the display reads LOAD and the START KEY (7) flashes, open the door and load the product.
4. Press the START KEY (7) to begin the cook cycle. The timer counts down.

NOTE: See the following for adjustments that can be made during any cook cycle.

5. When the cook cycle is complete, the alarm beeps and the display reads DONE. Press any key to silence alarm. Select CANCEL using the right display key to exit the cook cycle.
6. Remove the product from the oven.

MANUAL CORE PROBE COOKING

1. Press the TEMP KEY (4). Rotate the CONTROL KNOB (5) to enter the desired cavity cook temperature. Press any key to accept the value. The oven preheats to the new cavity set temperature.
2. Press the PROBE KEY (10). Rotate the CONTROL KNOB (5) to enter the desired product setpoint temperature.

3. Insert cooking probe into the center of the product. Plug the core probe into the CORE PROBE CONNECTION (20). Load the product into the oven.

NOTE: Pressing the START KEY (7) is not necessary while cooking with the core probe.

NOTE: See following page for adjustments that can be made during any cook cycle.

4. When the product has reached the setpoint temperature, the alarm beeps and the display reads DONE. Unplug the core probe to silence the alarm and exit the cook cycle.
5. Remove the product from the oven.

MANUAL CORE PROBE COOK & HOLD

1. Press the TEMP KEY (4). Rotate the CONTROL KNOB (5) to enter the desired cavity cook temperature. Press any key to accept the value. The oven preheats to the new cavity set temperature.
2. Press the PROBE KEY (10). Rotate the CONTROL KNOB (6) to enter the desired product setpoint temperature.
3. Press the center display key under the word HOLD. HOLD will be highlighted in blue indicating that the hold mode is active.
4. Insert cooking probe into the center of the product. Plug the core probe into the CORE PROBE CONNECTION (20).

NOTE: Pressing the START KEY (7) is not necessary while cooking with the core probe.

NOTE: See following page for adjustments that can be made during any cook cycle.

As the product temperature rises, the oven cavity temperature decreases.

5. When the product reaches the setpoint temperature, a short alarm sounds. The cavity temperature jumps to 4°F above the product setpoint. This temperature will hold the product, keeping it warm without continuing the cooking process.

The display counts up the time the product has been holding.

6. Unplug the core probe to remove the product from the oven.

PROGRAMMED COOKING

1. Press the RECIPES KEY (14). The display lists all of the currently programmed recipes. Rotate the knob until the desired product recipe is highlighted. Press OK using the right display key to select the product.
2. The oven preheats to the set temperature. When the display flashes LOAD, open the door and load the product.
3. Press the START KEY (7) to begin the cook cycle. The timer counts down.

NOTE: See following for adjustments that can be made during any cook cycle.

4. When the cook cycle is complete, the alarm beeps and the display reads DONE. Press any key to silence alarm. Select CANCEL using the right display key to exit the cook cycle.
5. Remove the product from the oven.

COOK CYCLE ADJUSTMENTS

The following adjustments can be made at any time during the cook cycle.

Hydro Burst

1. To add 100% humidity at any time during a cook cycle, press the HYDRO BURST KEY (12).
2. Rotate the knob to enter the length of time you wish to inject the moisture.
3. Select OK to start injecting humidity.

Vent Moisture from the Oven Cavity

1. Press the VENT KEY (8). This manually opens the vent until the key is pressed again to close it.

Cancel a Cook Cycle

1. To cancel the cook cycle, press the right display key under the word cancel.

Adding Time

1. Press the +1 MINUTE KEY (9). One minute is added to the timer for each time the key is pressed.

Fan Adjustments

1. Press the FAN KEY (11). Rotate the knob to select between four fan speeds (gentle, low, high and turbo). Press OK to select the desired fan speed.
2. Select FAN DELAY using the center display key. Rotate the knob to enter the desired fan delay. Select OK to save the fan delay increment.
3. Select FAN REV using the left display key. Rotate the knob to enter the desired length of time between fan reversals. Press OK to save the reversal increment.

COOL DOWN

NOTE: The unit can be cooled down rapidly for steaming, cleaning, etc.

1. To cool down the oven cavity, open the door and press the COOL DOWN KEY(15) and open the door.
2. The oven automatically shuts down when the oven reaches the cool down temperature.



Operation

Standard Controls

OVEN SHUTDOWN

1. Press the COOL DOWN KEY (15). The display reads COOLING and gives the actual cavity temperature. To speed up the cool down process, open the doors.
2. When the oven has cooled down, the display reads OFF PRESS POWER KEY TO TURN ON.

NOTE: The lights shut off and the vent closed automatically at the end of the cool down cycle.

PROGRAMMING A RECIPE

NOTE: The control can hold 100 recipes. Each recipe may have up to 10 cooking stages.

1. Press the RECIPES KEY (15). Rotate the knob to select NEW from the bottom of the recipe list.
2. Select EDIT using the left display key. A touchscreen keyboard is displayed. Use the keyboard to enter the desired recipe name.

NOTE: Product names may be up to 15 characters long and can contain letters, numbers, spaces and special characters.

Select OK to save the product name.

3. The control displays a set of default parameters for the first cooking stage. Select EDIT using the left display key to change these parameters.
4. Press the parameter you wish to change. Rotate the knob to the desired value. Select OK to save the new value.
5. Repeat step 4 for each parameter you wish to change.

To program a probe cooking stage:

- a. Press the PROBE/TIME parameter to toggle to Probe.
 - b. Rotate the knob to select the desired product set-point temperature. Select OK to save the temperature.
 - c. Rotate the knob to highlight the probe step in the step list. The hold toggle appears in the upper left corner of the screen. Rotate the knob to highlight the word HOLD. Select EDIT using the left display key to toggle between YES and NO.
6. To add a cooking step, select ADD using the right display key. The first step is copied. Repeat #5 to set parameters for the new step.
 7. To delete any step, rotate the knob to highlight the step. Select DEL RECIPE using the right display key.

8. To save the recipe and exit the edit mode, select ESC using the center display key.
9. To delete a recipe, with the recipe name highlighted during the edit process, press and hold the left display key until the display returns to the recipe list. The recipe will now be deleted from the list.

USING THE MANAGER TOOLS

The manager level screens provide tools to set the time and date, adjust the volume of the beeper and upload/download recipes using the USB port.

To access the manager level screens:

1. Press the TOOLS KEY (16).
2. Rotate the knob to select MANAGER. Select OK using the right display key.
3. Use the keypad to enter the code 6647.

USING THE USB PORT

1. From the manager level screens, rotate the knob to scroll to USB. Select OK using the right display key.
2. Rotate the knob to highlight either "Store menu to USB" or "Load menu from USB". Select OK using the right display key.

Store menu to the USB

1. Use the keypad to enter a new filename. Select OK using the right display key.
2. Once upload is complete, press ESCAPE to return to the previous screen.

Load menu from USB

1. Rotate the knob to select the desired file for download. Select OK using the right display key.
2. Once download is complete, press ESCAPE to return to the previous screen.

SmartTouch 2 Touchscreen Control

CONTROL DESCRIPTION

1. TOUCHSCREEN - interactive display for oven functioning and/or programming
2. USB Port and COVER - Use to transfer recipes and data to/from the control
3. HEAT CUTOFF - used to turn heat source off
4. CIRCUIT BREAKER - Provides circuit protection for the oven controls. DO NOT use as a power switch.
5. CORE PROBE CONNECTION - plug core temperature probe in here when using probe cooking



Figure 10



Operation

SmartTouch 2 Touchscreen Control

MANUAL MODE COOKING

1. Press POWER to turn on the oven.
2. Press MANUAL to proceed to the manual cook screen.
3. Set the following cooking parameters from the MANUAL screen.

Temperature - Press the temperature text and enter the desired oven temperature on the keypad provided. Press ENTER to save.

Cook Time - Press the time text and enter the desired cook time on the keypad provided. Press ENTER to save. Press the units text to toggle between hours/minutes and minutes/seconds.

Fan Speed - Press the fan speed text to toggle between Gentle, Low, High or Turbo.

NOTE: If the oven is preheating or cooling down, the fan speed will automatically run in high until the oven reaches the set temperature.

4. Press the FLYOUT MENU arrow to access the following parameters.

Actual Temp - Press to display the actual cavity temperature

Core Probe Cooking - Press to use the core probe cooking feature.

Add a Minute - Press +1 MIN to add 1 minute of time at any point during the cook cycle.

Hydro Burst

- a. To add 100% humidity at any time during a cook cycle, press the HYDRO BURST KEY (13).
- b. Rotate the knob to enter the length of time you wish to inject the moisture.
- c. Select OK to start injecting humidity.

Vent Position - The vent can be opened or closed by toggling the VENT icon at any point during the cook cycle.

Fan Delay - Press the fan delay icon. Use the provided keypad to enter a fan delay increment. Press ENTER to save.

Fan Reversal Interval - To adjust the fan reversal time, press the FAN REVERSAL icon. Enter the desired reversal interval on the keypad provided. Press ENTER to save.

Lights - At any time the lights can be turned on or off by toggling the LIGHT icon.

5. The oven preheats to the set temperature.

NOTE: START will not be displayed until the oven has reached the set temperature.

6. Press START to begin cooking. The display counts down. Press CANCEL at any time to stop the cook cycle.
7. When the cook time has expired, the display flashes DONE and the alarm sounds. Press CANCEL to silence the alarm. The display returns to the previous cook time setting.
8. Press BACK to exit out of MANUAL mode.

CORE PROBE COOKING

1. Press POWER to turn on the oven.
2. Press MANUAL to proceed to the manual cook screen.
3. Select Core Probe Cooking from the flyout menu.
4. Press the probe target text. Enter the desired finished product temperature on the keypad provided. Press ENTER to save.
5. Insert a core probe into the probe outlet on the control panel.
6. The HOLD button appears. To enable the Cook & Hold feature, press the hold button.
7. When the product has reached the set core temperature the display reads DONE.
8. **Cook Only** - Unplug the core probe and remove the product.

Cook & Hold - The oven cavity temperature adjusts to the optimum temperature for holding the product without overcooking. The display counts up the time the item has been holding. The cavity temperature jumps to 4°F above the product setpoint. This temperature will hold the product, keeping it warm without continuing the cooking process.



SmartTouch 2 Touchscreen Control

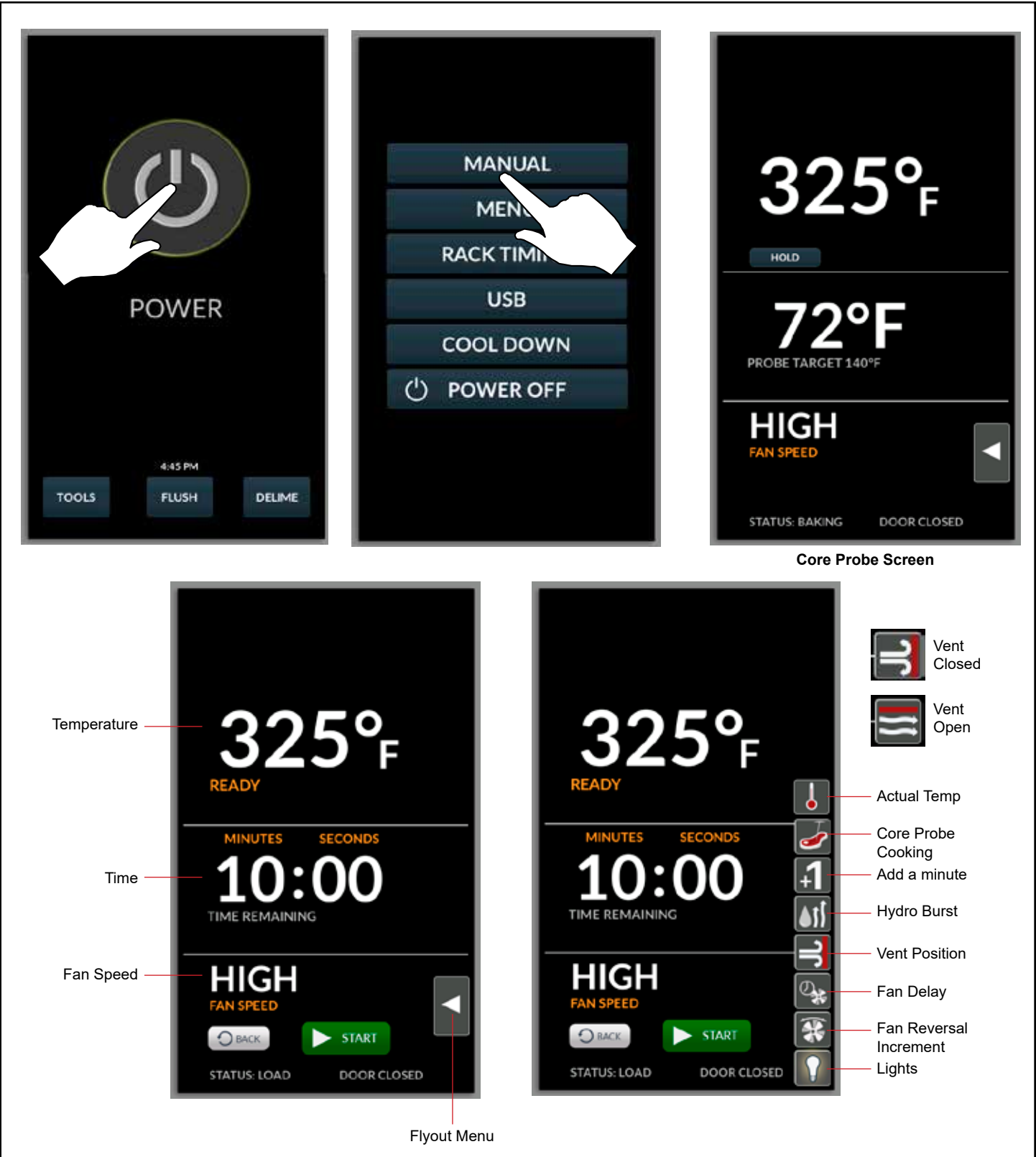

Figure 11



Operation

SmartTouch 2 Touchscreen Control

MENU MODE

Create a New Recipe

1. From the mode selection screen, select MENU.



Figure 12

2. Press right arrow key to advance to final category page. Then press NEW RECIPE key.

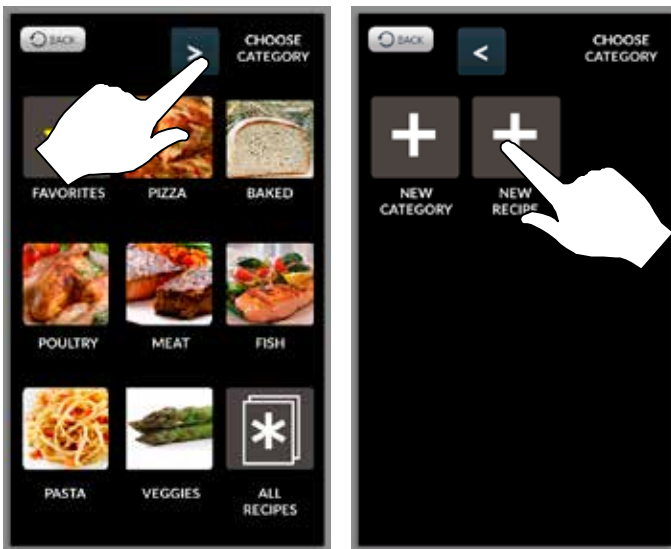

Figure 13

3. The NEW RECIPE screen is displayed. Press the camera icon.

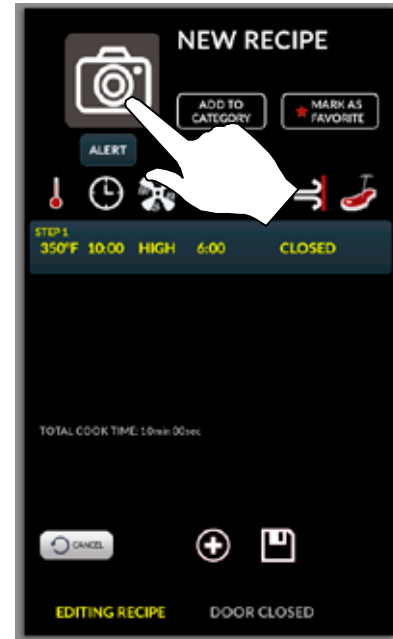

Figure 14

4. Select an icon to represent the recipe.



Figure 15

5. Press NEW RECIPE text. Use the keypad provided to enter a recipe name. Press the DISK ICON to save.

SmartTouch 2 Touchscreen Control



Figure 16

step.

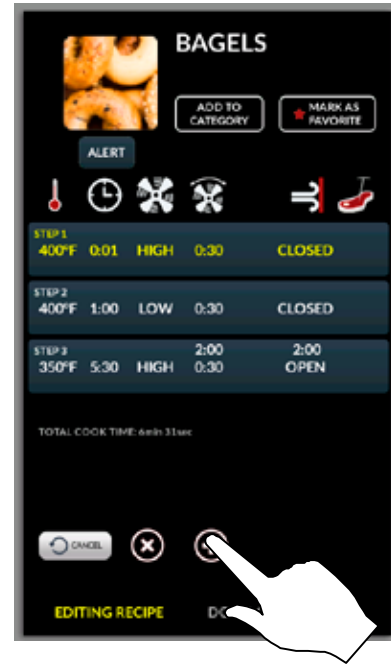

Figure 18

6. OPTIONAL: Press MARK AS FAVORITE if desired.
7. OPTIONAL: To add to an existing category, press ADD TO CATEGORY. Select category. Press DONE.

9. Once all steps have been entered, press the DISK ICON to save the recipe



Figure 17

Edit an Existing Recipe

1. From the mode selection screen, select MENU.
2. Press and hold the icon for the recipe you wish to edit.
3. Choose edit, copy or delete from the pop up menu.

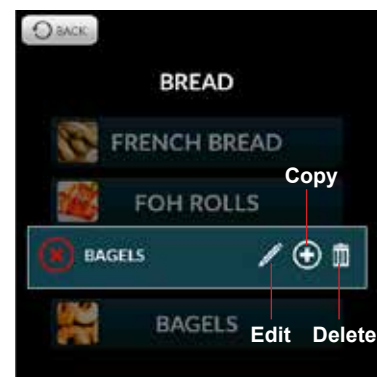

Figure 19

8. Enter parameters for the first cooking step. Press the icon above each parameter to adjust settings. Press the + to add a step. Press the X to delete the current



Operation

SmartTouch 2 Touchscreen Control

Create a New Category

1. From the mode selection screen, select MENU.



Figure 20

provided to enter a category name. Press the DISK ICON to save.

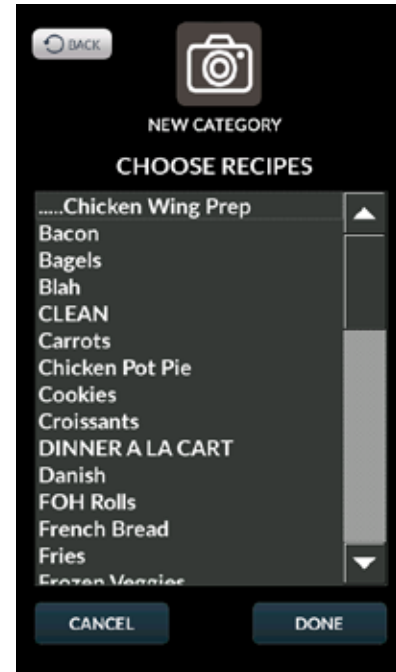

Figure 22

2. Press right arrow key to advance to final category page. Then press NEW CATEGORY key.

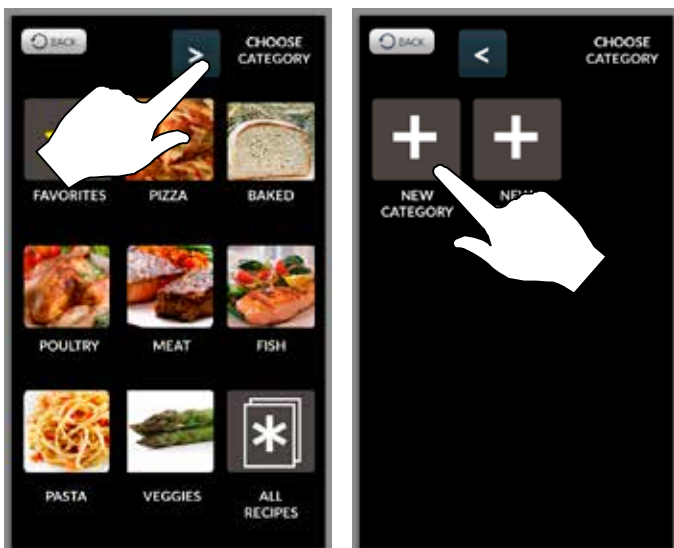

Figure 21

5. Select the recipes to include in the category. Press DONE to save.

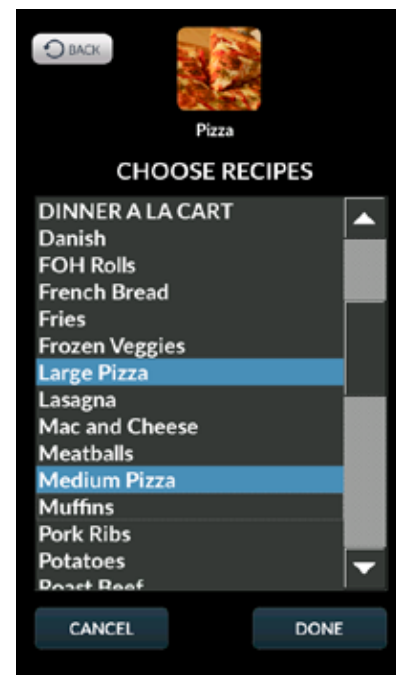

Figure 23

3. Press the camera to select an icon to represent the group.
4. Press the NEW CATEGORY text. Use the keypad



SmartTouch 2 Touchscreen Control

Edit Existing Category

1. From the mode selection screen, select MENU.
2. Press and hold the icon for the category you wish to edit.
3. Choose edit, copy or delete from the pop up menu.

Menu Mode Cooking

1. From the mode selection screen, press MENU.
2. Select a recipe using one of the following:
 - a. If the recipe is one of your favorites, press FAVORITES. Then select the recipe.
 - b. If the recipe is part of a category, select the category. Then select the recipe.
 - c. Press ALL RECIPES, scroll through the list using the left and right arrow keys. Select the recipe.



Figure 24

3. The control enters the Menu Cooking screen. Press the START KEY to begin the cook cycle.

NOTE: START will not be displayed until the oven has reached the programmed set temperature.

NOTE: If the oven is preheating or cooling down, the fan speed will automatically run in high until the oven reaches the set temperature.

NOTE: To edit a cooking step, press and hold the step before starting the program.

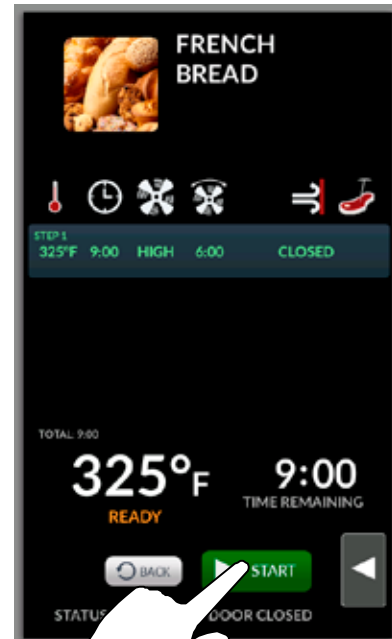

Figure 25

4. Press the FLYOUT arrow at any time to access Add a Minute, HydroBurst or the cavity lights. Press CANCEL at any time to stop the cook cycle.

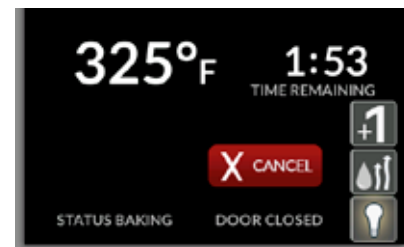

Figure 26

5. When the cook time has expired, the display flashes DONE and the alarm sounds. Press CANCEL to silence the alarm. The control returns to the recipe cook screen.
6. Press BACK to exit out of MENU mode.



Operation

SmartTouch 2 Touchscreen Control

RACK TIMING

Creating a Rack Timing Group

1. From the mode selection screen, select RACK TIMING. The SELECT GROUP screen is displayed.
2. Select ADD GROUP.

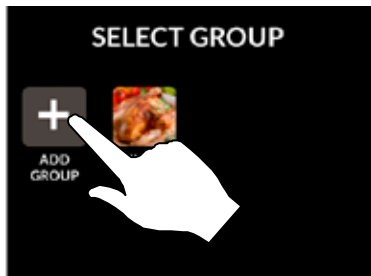

Figure 27

3. Press the pencil icons to edit the group name and cooking parameters. You may also select an icon to represent the group.
4. Enter desired cooking parameters.

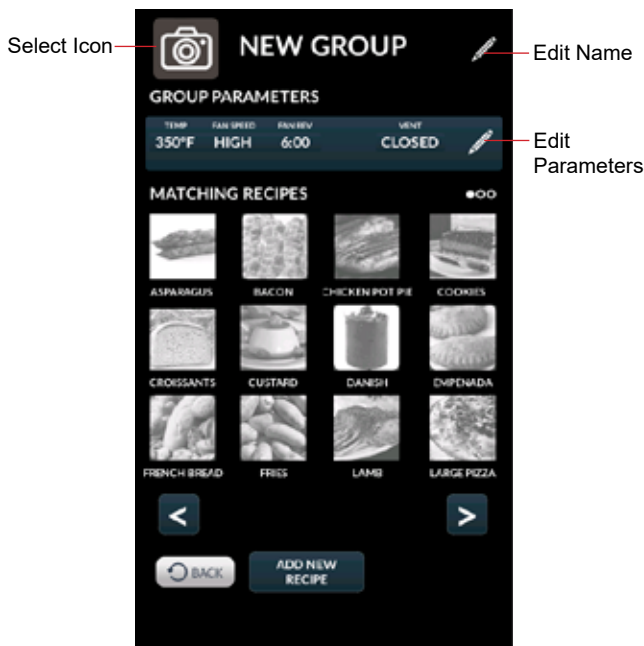

Figure 28

5. Select the recipes you would like to place in the group. Only recipes with parameters matching the group may be selected.



Figure 29

6. Press SAVE RECIPES TO GROUP.

Edit Existing Group

1. From the mode selection screen, select RACK TIMING.
2. Press and hold the icon for the group you wish to edit.
3. Choose edit, copy or delete from the pop up menu.

SmartTouch 2 Touchscreen Control

Using Rack Timing

1. From the mode selection screen, select RACK TIMING. The SELECT GROUP screen is displayed.
2. Select the desired food group for your product.

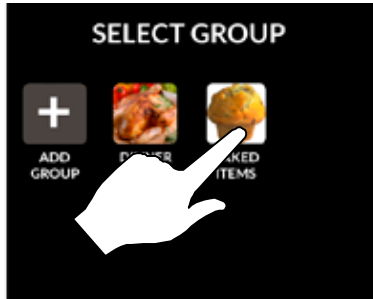

Figure 30

3. Press selected item icon at the top of the screen, drag to an open shelf. Or tap an open rack to assign the selected icon to that rack.

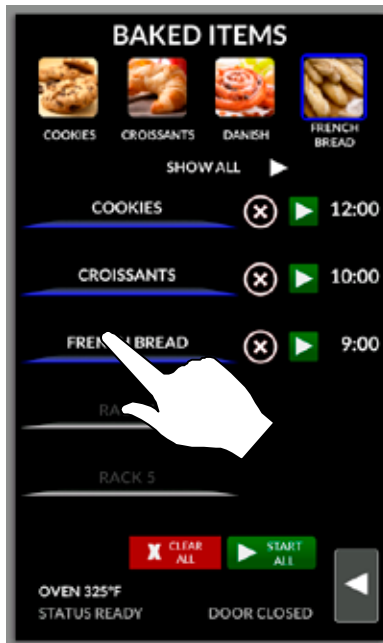

Figure 31

4. Start timers using the arrows. You can choose START ALL or start individual racks.

NOTE: START will not be displayed until the oven has reached the programmed set temperature.

NOTE: If the oven is preheating or cooling down, the fan speed will automatically run in high until the oven reaches the set temperature.

5. To add time, select +1 MIN key for individual racks or +1 MIN ALL key to add time to all racks. Each time the key is pressed, 1 minute of cook time is added.

During the cook cycle, individual rack timers will count down as the product is cooked. If you wish to cancel the bake, you can press the STOP ALL key, or you can stop individual racks.

6. Once a rack bake is complete the beeper will sound. Press STOP next to the rack that has completed the cook cycle. If all racks finish at the same time, press STOP ALL. STOP ALL.

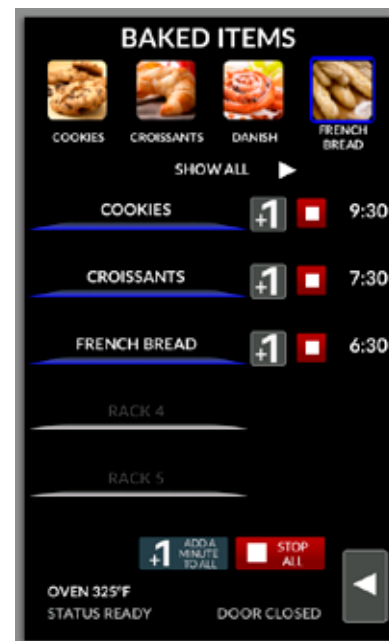

Figure 32

7. Press CLEAR ALL to escape the screen.

To Use Timer

1. Press the FLYOUT arrow at any time to access a timer or the cavity lights.



Figure 33



Operation

SmartTouch 2 Touchscreen Control

USB INTERFACE

To Access the USB Drive

1. From the mode selection screen, select USB



Figure 34

2. Enter the code 6647 on the keypad provided.



Figure 35

3. The following menu is displayed.



Figure 36

4. Insert USB drive into USB port on the control panel.

SmartTouch 2 Touchscreen Control

To Store Menu Data to a USB

NOTE: The following procedure may be used to store any type of data to a USB including HACCP, settings and fault logs.

1. Select STORE MENU TO USB.
2. Enter a filename for the menu data using the keypad provided. Press the disk icon to save.

NOTE: DO NOT use spaces in the filename.



Figure 37

3. The status screen is displayed. Press OK when the transfer is complete.

To Retrieve Menu Data from a USB

NOTE: The following procedure may be used to upload menu recipes and/or icons from a USB.

1. Select LOAD MENU FROM USB.
2. Select the file to download to the oven.

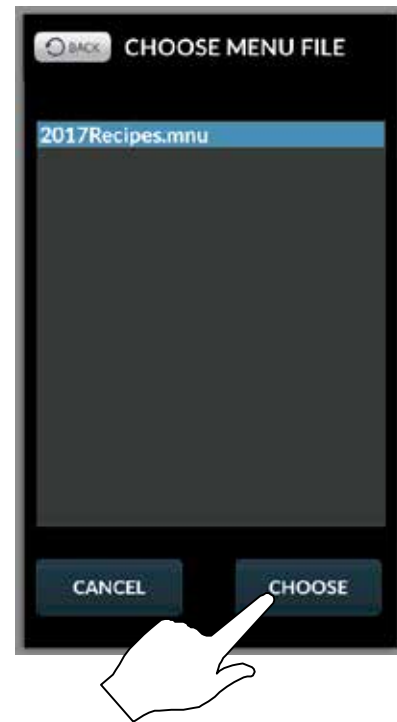

Figure 38

3. The status screen is displayed. Press OK when the transfer is complete.



Operation

SmartTouch 2 Touchscreen Control

COOL DOWN

1. From the mode selection screen, select COOL DOWN.

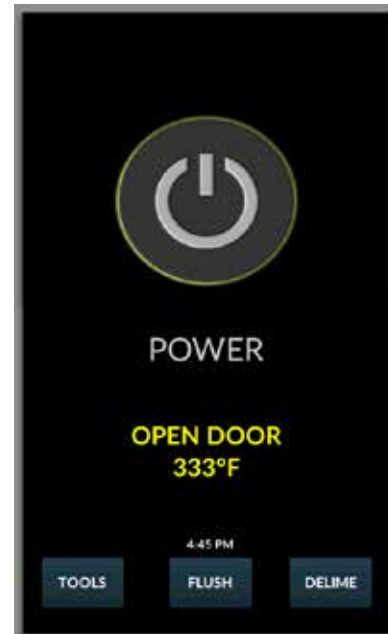

Figure 39

2. The display toggles between cooling and open door in yellow until the oven is cool.

NOTE: If the oven is shut down with the circuit breaker switch at the bottom of the front panel, the display will return to the power screen.

NOTE: The vent will automatically open and the fan will run on high speed during cool down to assist in lowering the cavity temperature. The fan and vent will disengage when the oven had cooled.



BCX shown

Figure 40

One Touch Touchscreen Control

Blodgett "One Touch" Control Description

1. Touch Screen – Interactive display for oven operation and programming.
2. USB Port and Cover – Use to transfer recipes and data to/from the control.
3. Heat Cutoff Switch – Use to turn heat source off.
4. Circuit Breaker – Provides circuit protection for the oven controls. DO NOT use as a power switch. See page 4 for example "Off" screen.
5. Core Probe Connection – Plug core temperature probe in here when using probe cooking.

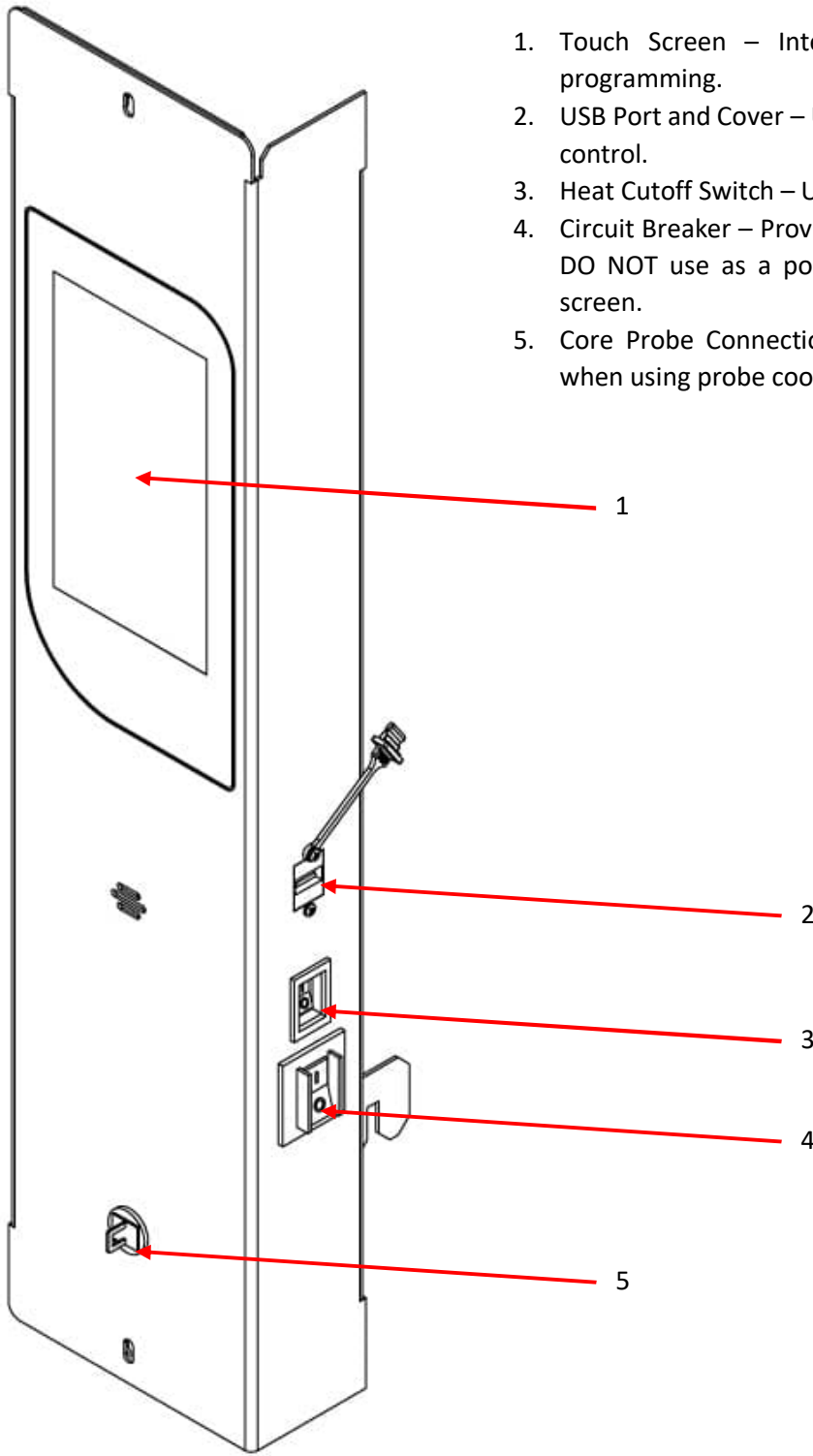



Operation

One Touch Touchscreen Control



MANUAL MODE COOKING



1. Touch the screen saver to access the Main home screen.

Note: The oven is "Off" when the Blodgett screen saver is displayed.

2. Touch MANUAL COOKING to proceed to the manual cook screen.
3. Set the following cooking parameters from the MANUAL screen:

 **Temperature** - Touch the temperature text and enter the desired oven temperature on the keypad provided. Press → to save.

 **Cook Time** - Touch the timer text and enter the desired cook time on the keypad provided. Touch → to save. Use the  key to select desired timer. (Timer, Continuous Timer, A La Carte)

 **Core Probe Cooking** – Touch  to use the core probe cooking feature instead of the timer. (See "Core probe cooking" for more info)

 **Humidity** – Touch the humidity text and enter desired level to adjust cavity moisture content. Press → to save.

 **Fan Speed** - Touch the fan speed text to select between Gentle, Low, High or Turbo.

NOTE: If the oven is preheating or cooling down, the fan speed will automatically run in high until the oven reaches the set temperature.

 **Vent Position** - The vent can be toggled open or closed by toggling the **Vent Position** icon at the beginning or at any point during the cook cycle.

NOTE: When vent is opened on HVH models, air is actively forced through the system. This allows for the rapid evacuation of moisture from the cavity.

 **Fan Reversal Interval** - To adjust the fan reversal time, touch the **Fan Reversal** icon. Enter the desired reversal interval on the keypad provided. Press → to save. The default reversal is 6 minutes.

 **Hydro Burst** - Touch to add 100% humidity at any time. Use the provided menu to select desired length of hydro burst. The display counts down the hydro burst time remaining.

 **Lights** - At any time the lights can be toggled on or off by touching the **Light** icon.

4. The oven preheats to the set temperature. The user can load the product and set the timer. Cooking parameters can be changed at any point during the cook and the timer will stay active unless a new time is entered on the timer.
5. Once a timer has been entered the oven will begin cooking.

+/- 1 Minute – While cooking, press +1 min or -1 min to add or subtract 1 minute of cook time at any point.



6. When the cook timer has expired, the display flashes **DONE** and the alarm sounds. Touch anywhere to silence the alarm and return to the previous cooking parameters screen.
7. Touch the back arrow in the top left corner of the screen to exit out of MANUAL COOKING mode.

One Touch Touchscreen Control

CORE PROBE COOKING

1. Touch the screen saver to access the Main home screen.

Note: The oven is "Off" when the Blodgett screen saver is displayed.

2. Touch MANUAL COOKING to proceed to the manual cook screen.
3. Insert the core probe into the probe outlet on the control panel. The probe cook symbol can now be selected, touch the  in the timer selection box to enter core probe cooking mode.
8. Touch the probe target temperature text. Enter the desired finished product temperature on the keypad provided. Touch → to save.
9. To access other core probe functions, touch the  key and select the desired function from the list.

Normal – For a normal core probe cook, enter a cavity set temp, and a target product temp. The oven will remain in the cook cycle until the product temp has reached the target temperature.

Cook and Hold – For a Cook and Hold, enter a cavity set temperature and a product target temperature. As the product temperature increases, the cavity set temp will decrease. When product has reached its target temperature, the cavity temperature will be equivalent to the finished product temperature. This allows the finished product to be held in the cavity without overcooking.

Delta T – For a delta-T cook, enter a target product temperature. The oven will calculate the cavity set temperature based on the product temperature. As the product temperature increases the cavity set temperature will also increase until the product target temperature is reached.

Note: Disable pre-heat lockout in the general oven settings to properly access Delta T.

10. When the product has reached the set core temperature the display will read DONE.
11. Unplug the core probe and remove the product.

A-La-Carte COOKING

1. Select the "A La Carte" function from the cook timer menu shown below to access manual cooking with multiple timers.

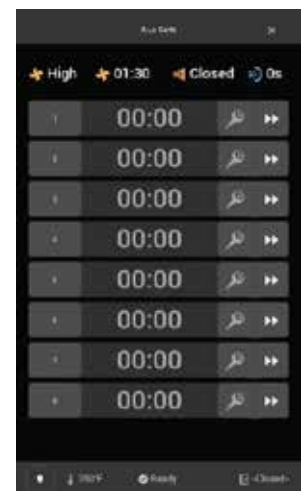

NOTE: The number of rack timers is configurable in settings.



Operation

One Touch Touchscreen Control

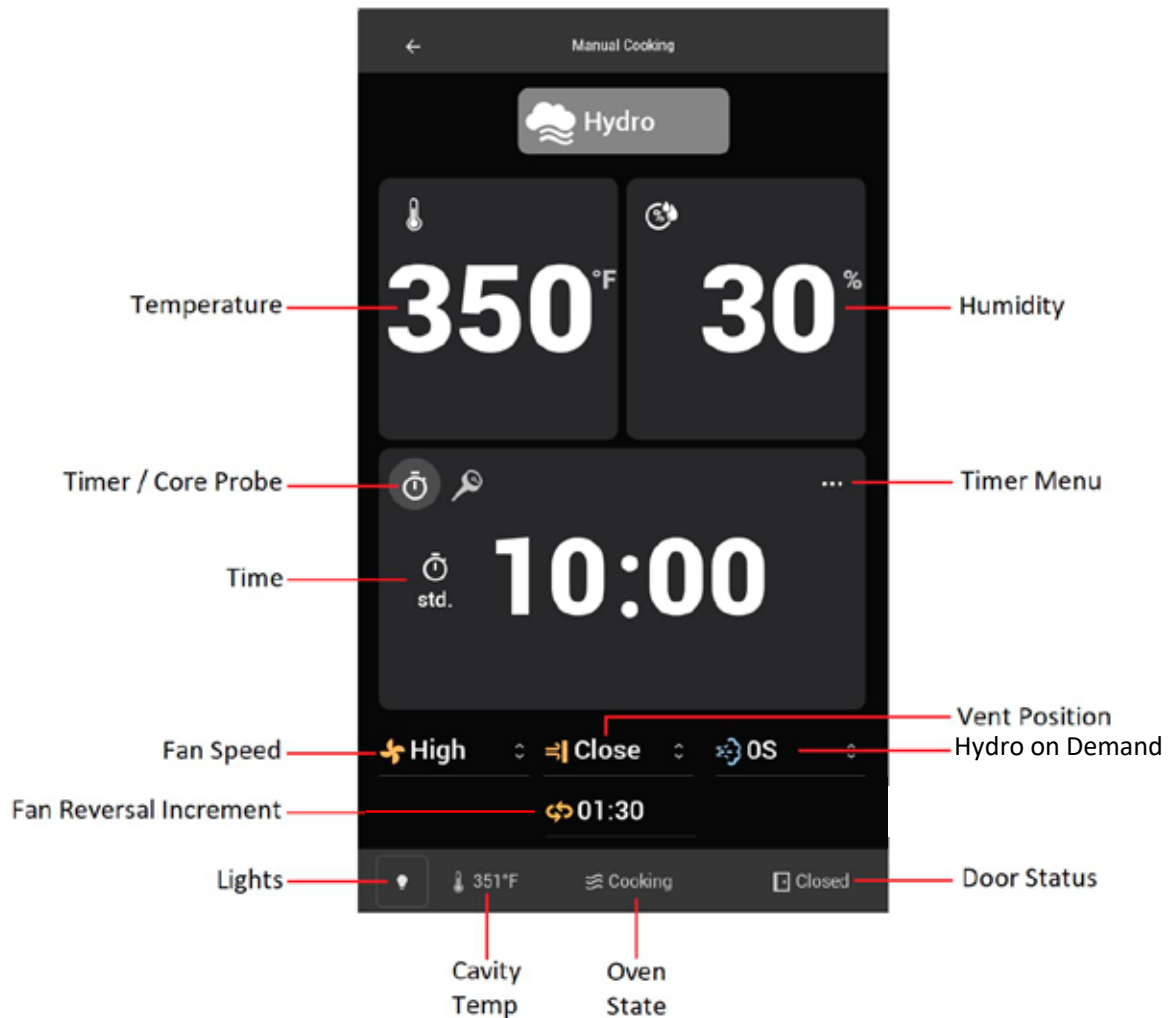
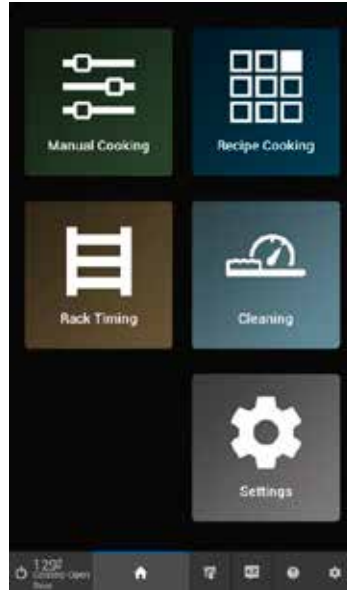
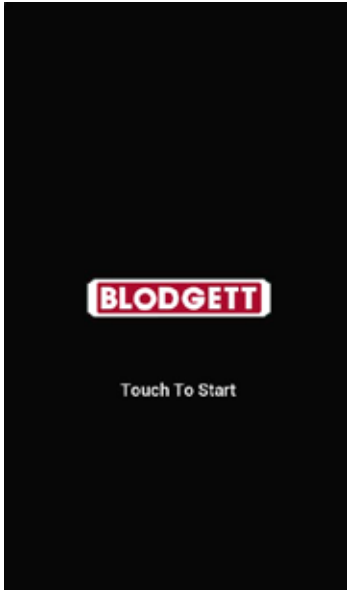

One Touch Touchscreen Control

Recipe Cooking

Create New Recipe

1. From the home screen, select RECIPE COOKING.



2. Press Create Recipe.

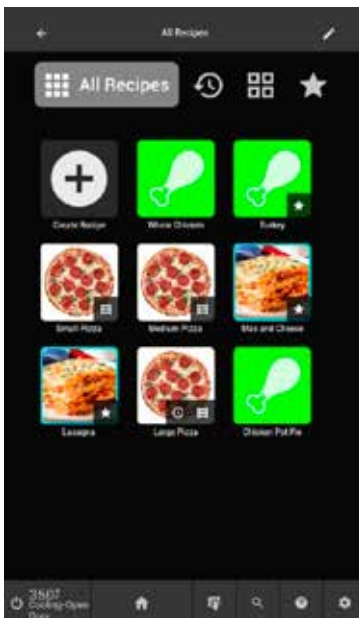

3. Use the  key and select recipe details.

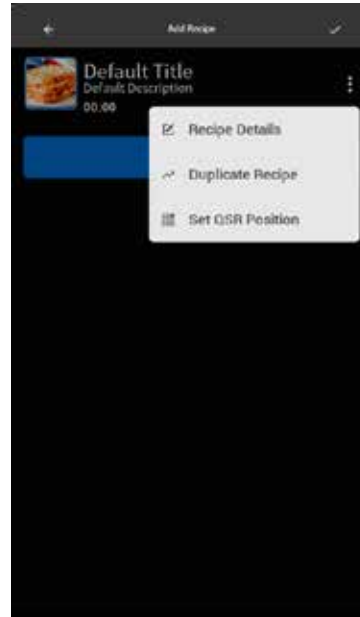

4. Touch each detail to edit. Using the presented keyboard, enter a recipe title and a short description. Use the → key to save.





Operation

One Touch Touchscreen Control

5. Touch **Select Image** to assign a new image to the recipe. Both general icons and custom images can be used.



7. OPTIONAL: Selecting **Change Color** will present a palate to change the recipe icon color/border.

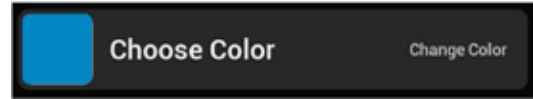

8. OPTIONAL: Select **Favorite** to mark the recipe as a favorite. The star will illuminate, and the recipe will be available from the favorites menu.

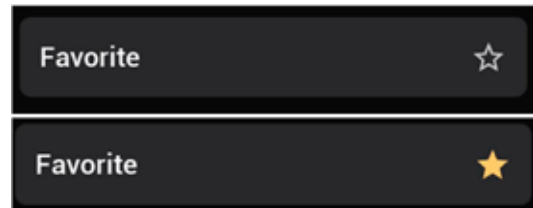

9. Once all desired fields have been completed touch the key to save the recipe details.

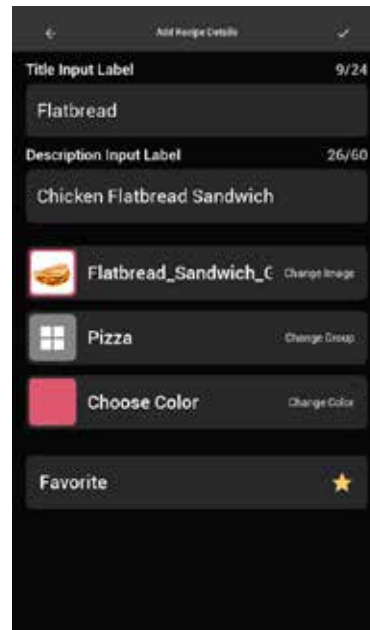

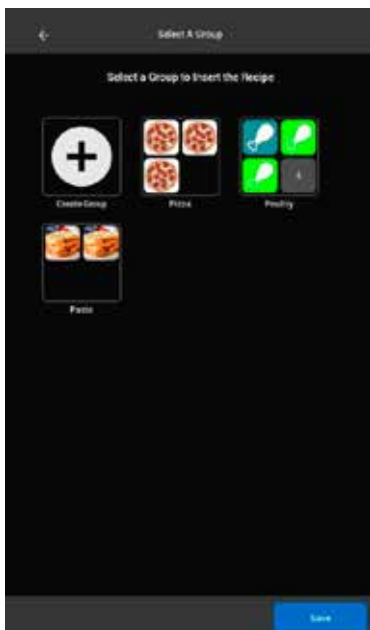

6. OPTIONAL: From **Recipe Details**, touch **Set Group** to add the new recipe to one or more existing groups or create a new group. (See Creating Groups)

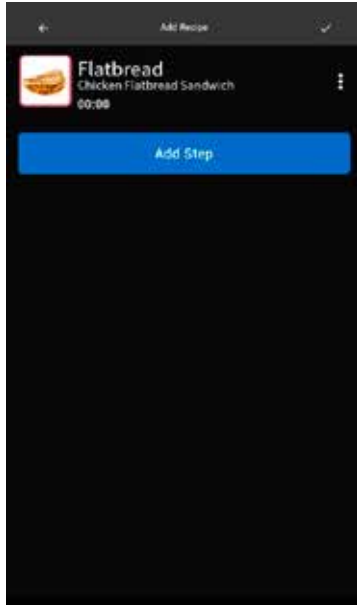

One Touch Touchscreen Control

10. Select **Add Step** to display the list of available cooking modes.





12. Enter the parameters of the selected cook mode similarly to a manual cook. Touch the  key to save the step.

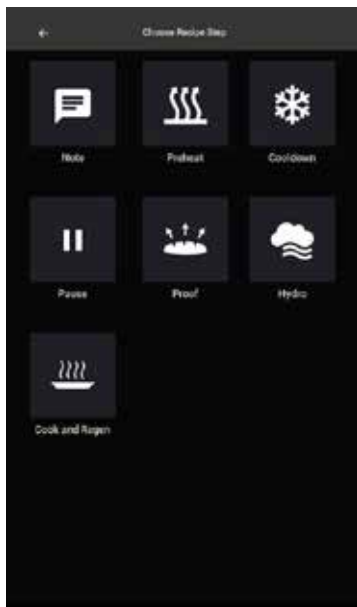

11. Select the first cooking step of the recipe.



 **Fan Delay** - Recipe cooking can delay the rotation of the blower wheel in the cooking cavity. Touch the fan delay icon and use the provided keypad to enter a fan delay increment. Press → to save.

13. Repeat steps 10-12 until the recipe is complete. Use the  key to create the recipe. Use the up and down arrows on each step to change the order the steps are executed.

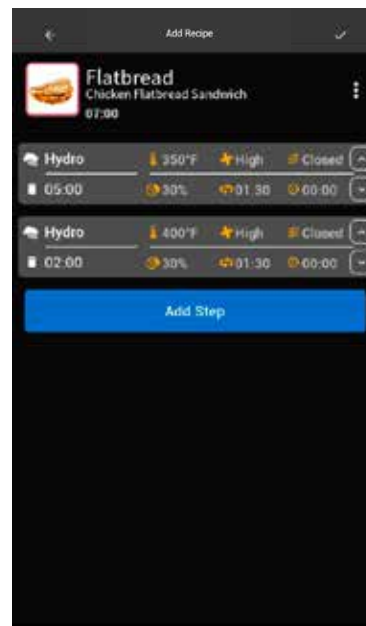

TIP: Start your recipe with a Preheat, followed by a Note to Load the product.



Operation

One Touch Touchscreen Control

Edit Existing Recipe

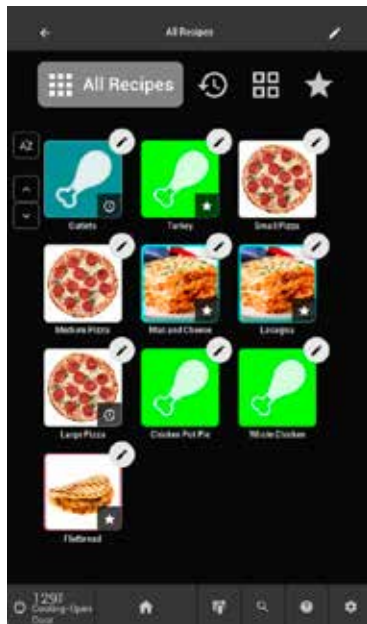

1. From the recipe selection screen touch the  key to enter edit recipe mode. Touch the pencil icon on any recipe to open the recipe edit menu.

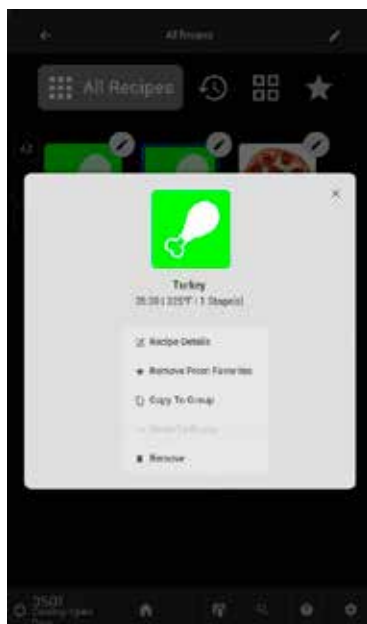

2. From the recipe edit menu, recipes can be: added to a group, selected as a favorite, or deleted. Select **Recipe Details** to open the recipe edit screen.



3. The edit recipe screen operates just like the add recipe screen.

- Use the  key to edit recipe details.
- Touch **add step** to create a new cooking step for the recipe.
- Touch any existing step to edit it.
- Use the up/down arrows to the right of each step to change the order the steps are executed in.
- Touch the  key in the top right corner to confirm changes, or use the back arrow to discard changes.

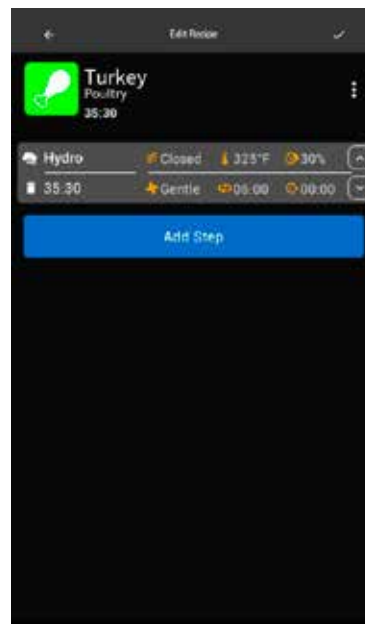

One Touch Touchscreen Control

Create New Group

1. From the home screen, select recipe cooking.
3. Select Create Group.

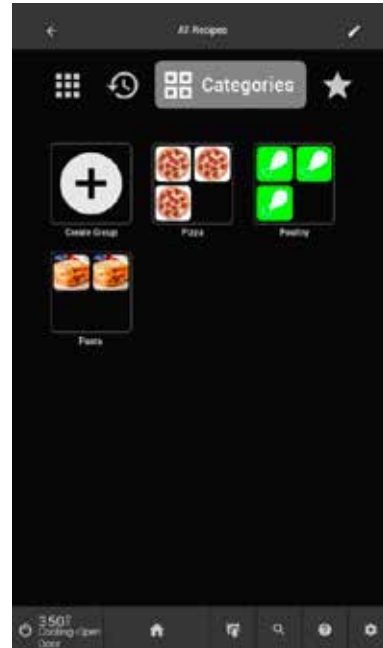

2. Select the Categories icon at the top of the screen.
4. Enter the desired group name. Touch the blue arrow to save and continue.

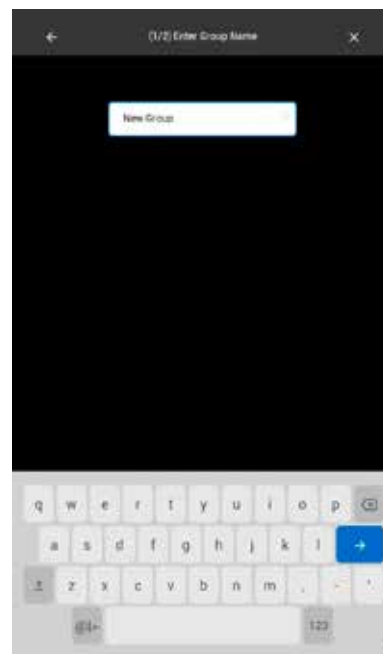
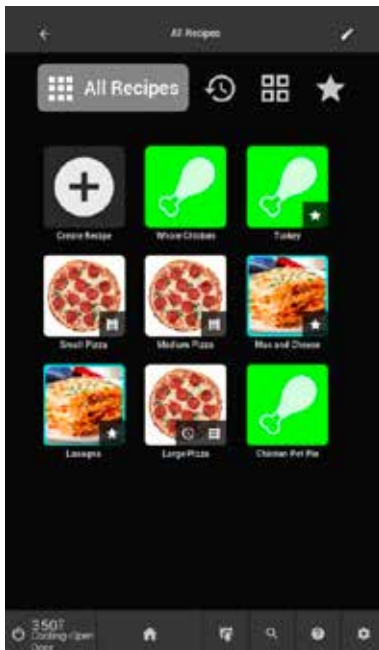



Operation

One Touch Touchscreen Control

5. Select the recipes to be featured in the newly created group. Then select **OK** to create the group.
2. Select **Edit Group Name** to change the name for the group. Select **Edit Group Contents** to add or delete recipes held in the group.



Edit Existing Group

1. From the group selection screen select the  key to enter edit group mode. Touch the pencil icon on any group to open the group edit menu.

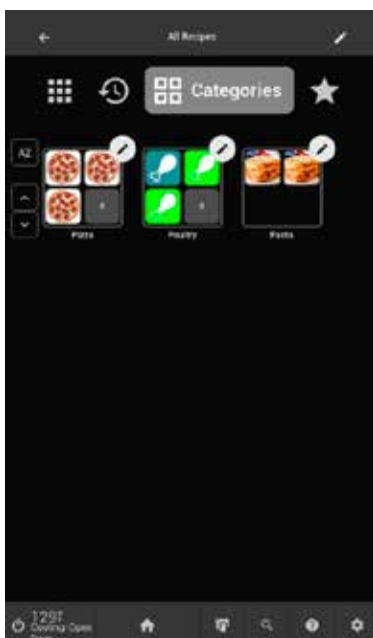

One Touch Touchscreen Control

Recipe Cooking

1. From the home screen, select **Recipe Cooking**.



2. From the recipe cooking screen, use the toolbar at the top of the screen to navigate between: All Recipes, Recent Recipes, Categories, and Favorites.

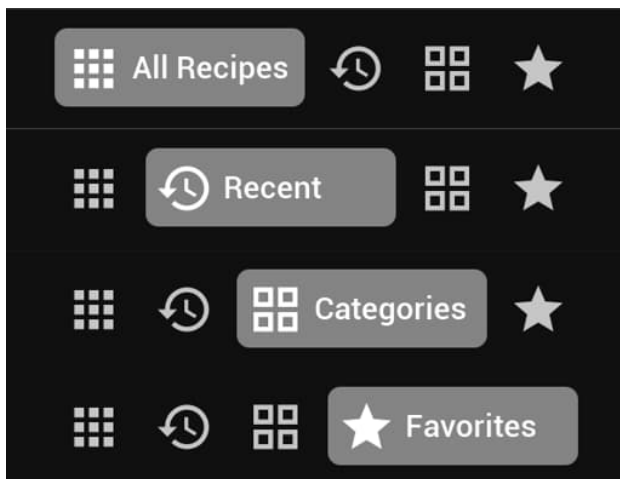

3. Swipe up and down to scroll through the existing recipes. Touch a recipe to select it for cooking.

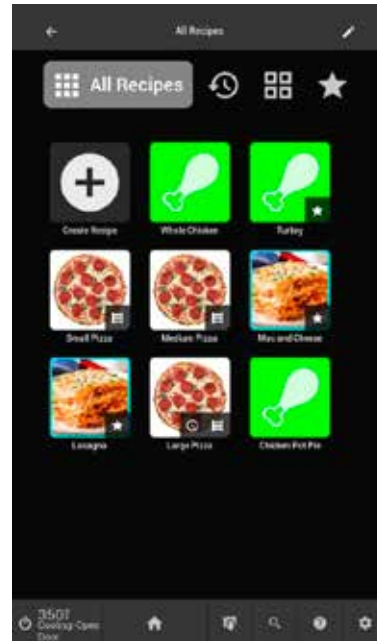

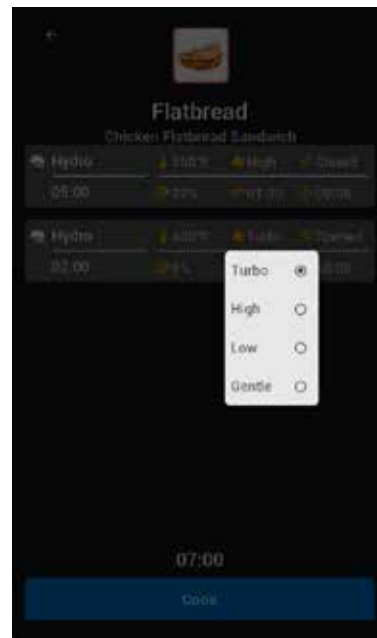

4. From the selected recipe screen, each parameter of the existing steps can be edited individually by touching them. Select **Cook** to begin the recipe cook.







Operation

One Touch Touchscreen Control

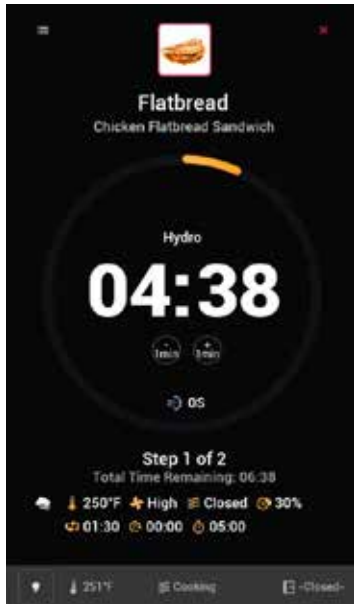
- At any time during the cook:
 - Touch +1min. or -1min. to add or subtract a minute from the remaining step timer.
 - Touch the  icon for hydro burst.
 - Touch  to toggle the cavity lights.



- Touch the  icon in the top left corner of the screen to view the current recipe steps. Select any parameter on a **future** step to adjust the recipe in real time. Touch the cook type icon to skip to that step.

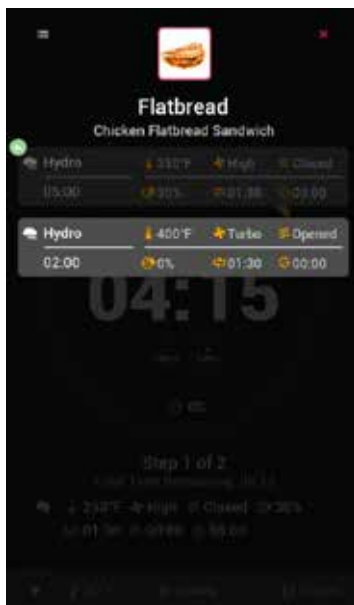

- When the cook time has expired, the display will flash **Recipe Complete**, the alarm will sound, and a timer will start to show the elapsed time since the recipe has completed.
 - Select **Finish** to return to the recipe selection screen.
 - Select +1min to add 1 minute to the previous step.

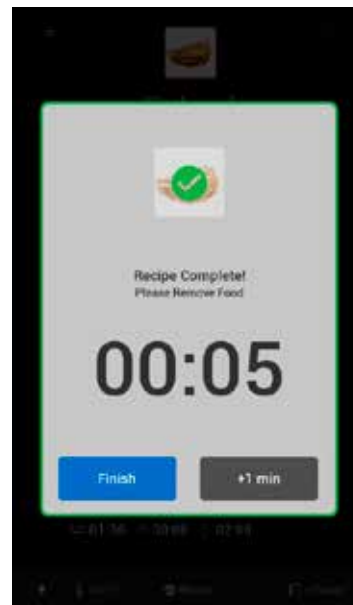



One Touch Touchscreen Control

Creating A Rack Timing Group

1. From the home screen, select **Rack Timing**. The Menu Planner screen will be displayed. Select **Create Group**.



2. Touch the  key to open the group creation menu. Touch **menu details**. Enter a title and description for the group. Touch  to save.



3. Touch **Add Recipes** to display the recipe selection screen. The first recipe selected will dictate the parameters for the entire group. Touch the  key to save and return to the **Create Menu** screen.
NOTE: Only recipes with the same cook mode, set temp, and humidity parameters can be added to the same group.

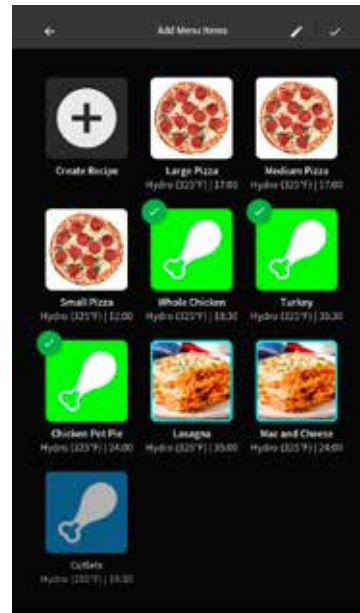

4. From the **Create Menu** screen, select the  key to save the rack timing group.





Operation

One Touch Touchscreen Control

Editing A Rack Timing Group

- From the rack timing menu planner, touch the pencil icon in the top right corner of the screen. The group edit icons will appear on each group.



Cooking with Rack Timing

- From the **Home Screen** select **Rack Timing**. The group selection screen will be displayed. Select a group, the menu summary screen will be displayed.

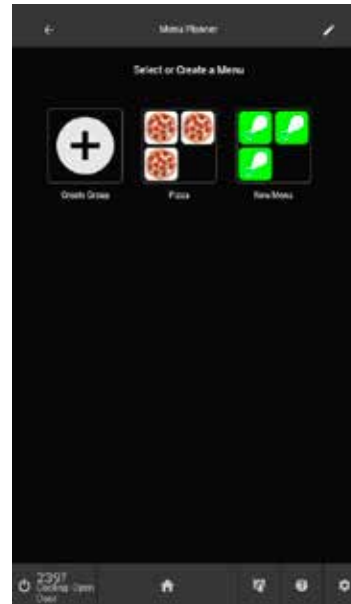

- To edit a group, touch the pencil icon on the group icon, then select **Edit Menu** in the presented window.

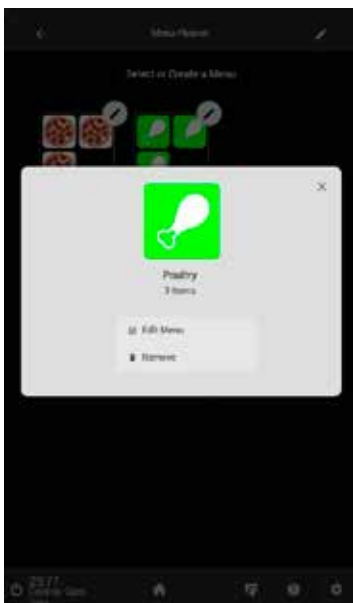

- Select **Cook** to open the rack timer and begin cooking.



- Once the group has been edited, select the  key to save the rack timing group.

One Touch Touchscreen Control

- The oven will begin preheating to the group's defined set temperature. The status indicator at the bottom of the screen will alert the user when the oven is ready, and the alarm will sound.

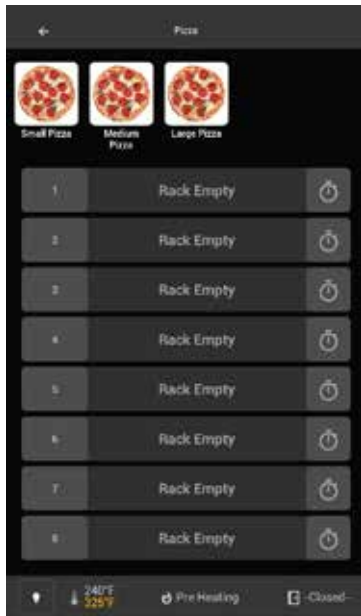

- Select the desired recipe at the top of the rack timing screen and select an open rack to set the timer. Recipes can also be selected and dragged to the desired position.

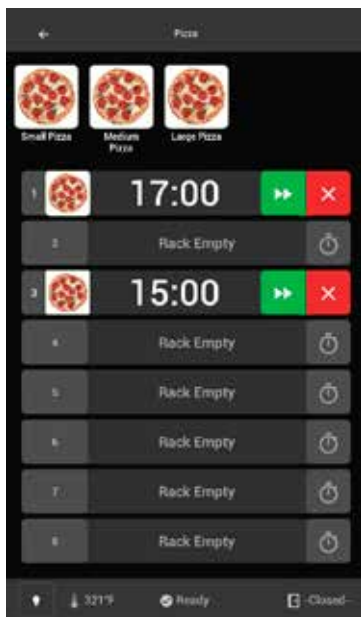

- Start timers by using the green arrow keys OR the timers will automatically start when the door is opened, then closed (product is loaded).

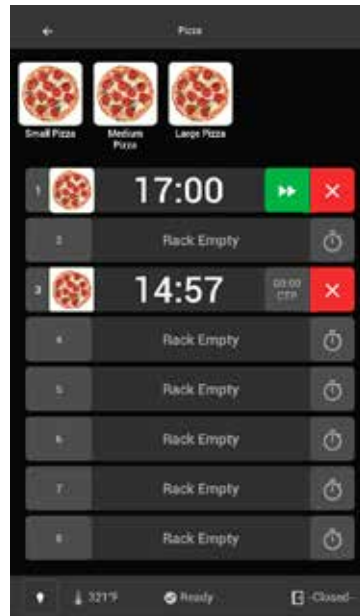

NOTE: Start key will not be displayed until the oven has reached the group set temperature.

- When a timer expires, the alarm will sound, and the corresponding rack will flash **DONE**. Touch the yellow unload product button to reset the timer. Use the +1min. key to add 1 minute to the timer.

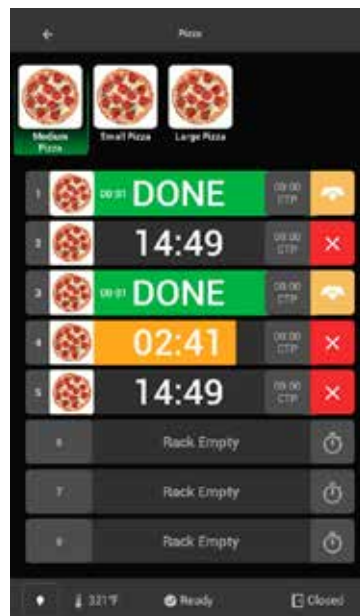



Operation

One Touch Touchscreen Control

7. To cancel a cook, press the  key next to the timer. To exit rack timing, touch the back arrow in the top left corner. A window will appear to ensure exiting was intentional. Select **Exit** to confirm.

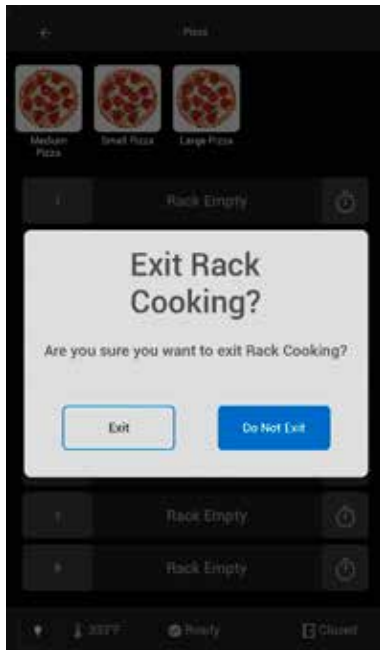

Cooling the Oven

1. To cool the oven, exit the current cooking mode using the back arrow in the top left corner. On the **Home Screen**, the oven will activate cool down mode. During **Cool Down** the vent will open and the main fan will run on high until the cavity reaches a safe temperature; 105°F. The main fan will continue to run with the door open for faster cooling.

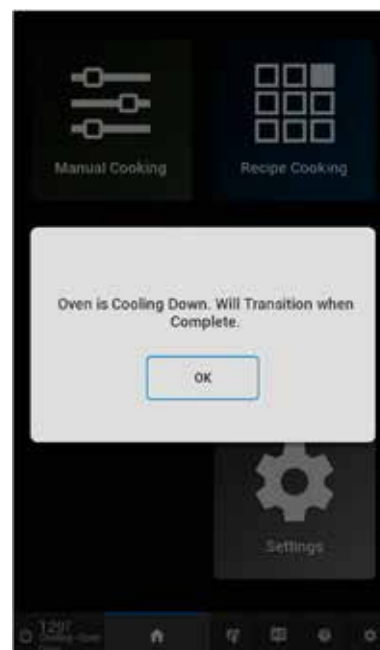

One Touch Touchscreen Control

Cleaning

1. Touch the screen wipe quick-key to wipe the control without causing inadvertent inputs. A 5 second count down will appear on the screen.

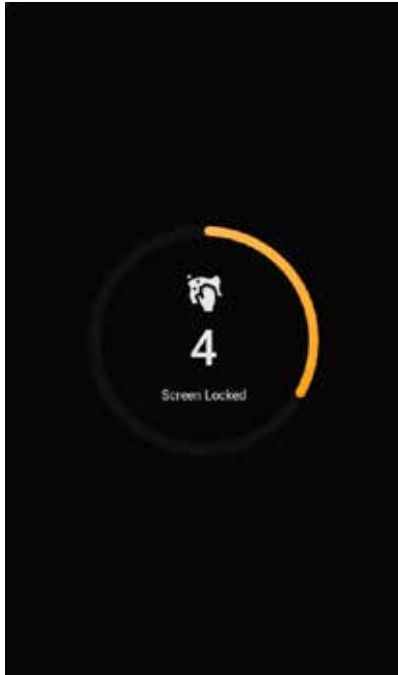

2. Select the Cleaning icon from the Home screen.
3. The Hydrovection has a Wash Cycle function that prepares the oven for manual cleaning. Select the wash cycle and the oven will run at high steam and low temperature.

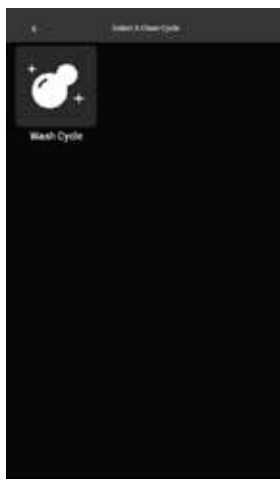

See other relevant cleaning information in the Maintenance section of this user manual.

USB Interface

1. Access the USB Export screen by touching the  button at the top left of the General Settings screen and then selecting "Menu."

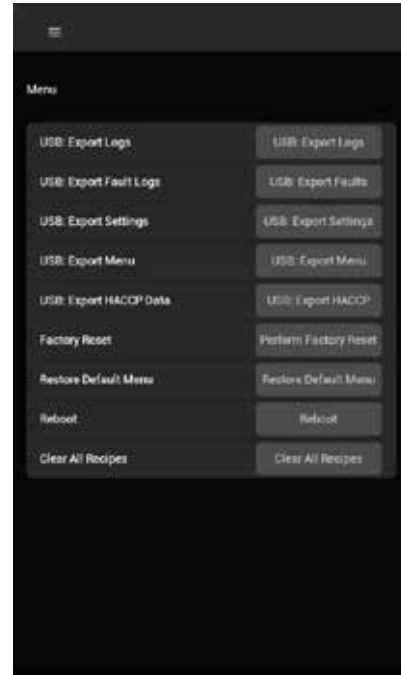

2. Touch the desired option and input a name for the file to export to the USB. Press the enter button and the export will be verified by a pop-up on the screen.

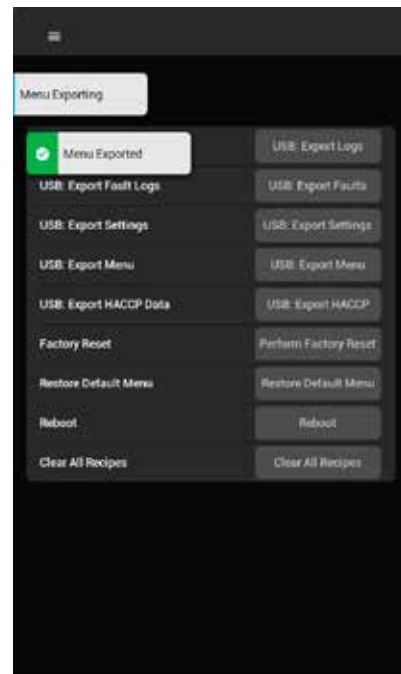



Operation

One Touch Touchscreen Control

3. To import from a USB, first navigate to the General Settings screen and toggle the field “Firmware Update” to show green. This setting activates the USB pop-up feature for when a USB is inserted into the USB port. The setting is off by default.
4. With the aforementioned setting turned on, insert a USB containing the menu, settings, and/or software you are looking to install on the oven.
5. Touch the circle next to the appropriate file and a dot will appear in the circle indicating selection. Touch the “Next” button to continue.

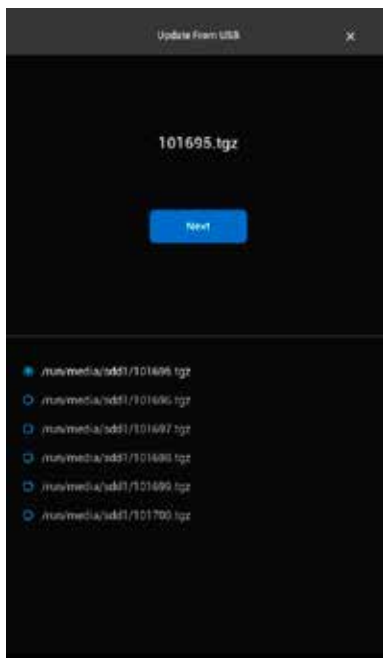

6. Touch the box to Select All, or select individually and then press Update.

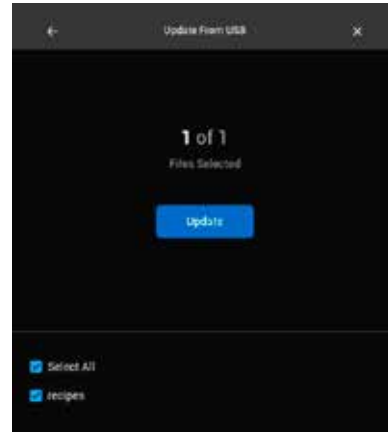

7. The control will install the menu or the settings and indicate a successful upload. Or, in the case of a Software Update, the control will display a progress screen before indicating a successful upload.

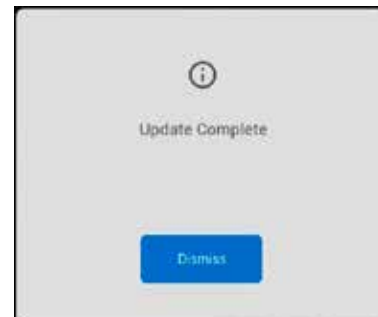
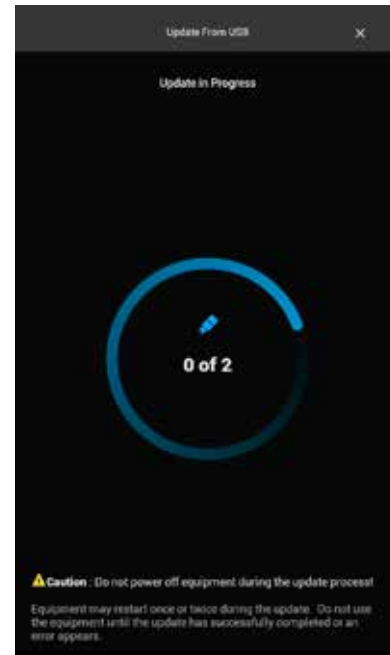



Spray Bottle Operating Procedure

NOTE: Only use a commercial oven cleaner/degreaser with the spray bottle. DO NOT use chemicals that are not intended as oven cleaners. See chemical manufacturer's information for intended use.

1. Unscrew the sprayer head and fill the container to the MAX mark. Screw the head assembly on firmly to ensure an airtight seal. The liquid must be clean and free from foreign matter. Do not overfill - space must be left for compressing air.



Figure 41

2. To build up pressure, pump approximately 20 full strokes when the container is filled with liquid. The higher the pressure, the finer the spray. If the container is only partially filled, then more pumping is required to compress the additional air space.



Figure 42

3. To spray, depress the trigger with your thumb.



Figure 43

4. Adjust spray nozzle for a wide spray pattern.
5. After a period of spraying, the pressure will drop. Restore the pressure by operating the air pump.
6. Release pressure after use by inverting the spray head and depressing the trigger or by slowly unscrewing the spray head assembly which will allow air to escape from around the filling aperture.
7. After use, rinse the spray bottle with clean water and check that the hole in the nozzle is perfectly clean and clear. Warm water (not hot) used with a household detergent is a useful cleaning agent for this purpose.

NOTE: Further information can be found in the instruction leaflet supplied with your spray bottle.



WARNING!!

Protective clothing and eyewear should be worn while using cleaning and deliming agents.

To order additional bottles or spray heads use the following part numbers:

Complete Spray Bottle - P/N R0006

Spray Head Repair Kit - P/N R6332



Maintenance

Cleaning and Preventive Maintenance

DAILY CLEANING

Cleaning the Interior

Daily cleaning of the oven is essential for sanitation, and to ensure against operational difficulties. The stainless steel cavity may corrode with improper cleaning of the oven. Use an oven cleaning detergent in conjunction with the supplied spray bottle.

For difficult cleaning, allow the spray-on oven cleaner to work longer before rinsing.

1. Open the oven door. Place the oven in cool down mode. Let the oven cool to below 140°F (60°C).
2. Fill the spray bottle with a mild oven detergent. **DO NOT use abrasive cleaners on your Blodgett Combi. Be sure to follow the MSDS or safety instructions on the bottle of your oven cleaner.**
3. Pump the bottle twenty times to build up pressure. The higher the pressure, the finer the spray. Spray the oven interior. Turn the nozzle to adjust the spray pattern.
4. Close the door. Place the oven in steam mode for 10 minutes.
5. When finished steaming, open the door and rinse the interior with the attached spray hose.



Figure 44

6. Leave the door open overnight to vent the oven. If the oven will not be used for an extended period of time, place the oven in hot air mode to dry.



Figure 45

Cleaning the Exterior

The exterior of the appliance may be cleaned and kept in good condition with a light oil. Saturate a cloth and wipe the appliance when it is cold; wipe dry with a clean cloth.



WARNING!!

DO NOT spray the outside of the oven with water or clean with a water jet. Cleaning with a water jet can impregnate chlorides into the stainless steel, causing the onset of corrosion.

Clean the air intake / cooling fan behind the oven so that it is free of all lint, grease or other inhibitors of air flow. Keeping this area free of obstruction will extend the life of the components.

PREVENTIVE MAINTENANCE

The best preventive maintenance measures are the proper initial installation of the equipment and a program for cleaning the appliance routinely. The oven requires no lubrication. Contact the factory, the factory representative or a local Blodgett service company to perform maintenance and repairs should they be required.

WEEKLY CLEANING

In addition to the daily cleaning it is necessary to clean the air intakes on a weekly basis. Air intakes provide necessary cooling air to the internal components. They are generally located on the rear and sides of the equipment.