

BLODGETT® **BLODGETT**® **BLODGETT**® **BLODGETT**®

BLODGETT® **BLODGETT**® **BLODGETT**®

BLODGETT® **BLODGETT**® **BLODGETT**® **BLODGETT**®



HV-100E, HV-100G, HVH-100E AND HVH-100G INSTALLATION - OPERATION - MAINTENANCE



BLODGETT OVEN COMPANY

www.blodgett.com

42 Allen Martin Drive, Essex Junction, Vermont 05452 USA Telephone: (802) 658-6600 Fax: (802) 864-0183

PN 59234 Rev I (2/24)

© 2021 - G.S. Blodgett Corporation

Your Service Agency's Address:

Model

Serial number

Oven installed by

Installation checked by

TABLE OF CONTENTS

IMPORTANT

WARNING: Improper installation, adjustment, alternation, service or maintenance can cause property damage, injury or death. Read the installation, operation and maintenance instructions thoroughly before installing or servicing this equipment.

INSTRUCTIONS TO BE FOLLOWED IN THE EVENT THE USER SMELLS GAS MUST BE POSTED IN A PROMINENT LOCATION. This information may be obtained by contacting your local gas supplier.

FOR YOUR SAFETY

Do not store or use gasoline or other flammable vapors or liquids in the vicinity of this or any other appliance.

The information contained in this manual is important for the proper installation, use, and maintenance of this oven. Adherence to these procedures and instructions will result in satisfactory baking results and long, trouble free service. Please read this manual carefully and retain it for future reference.

ERRORS: Descriptive, typographic or pictorial errors are subject to correction. Specifications are subject to change without notice.

INSTALLATION

Oven Description & Specifications	2
Utility Connections - Standards and Codes	4
Oven Location and Ventilation	5
Leg Attachment	6
Caster Attachment	7
Stacking	8
Plumbing Connections	10
Electrical Connections	12
Gas Connection	13

OPERATION

Gas Hose Restraint	15
Safety Information	16
Standard Control	17
SmartTouch 2 Touchscreen Control	21
One Touch Touchscreen Control	33

MAINTENANCE

Spray Bottle Operating Procedure	51
Cleaning and Preventive Maintenance	52



Installation

Oven Description & Specifications

ABOUT THE HYDROVECTION

Blodgett Hydrovection ovens are quality produced using high-grade stainless steel with first class workmanship.

The multiple speed fan, which is guarded against accidental finger contact, is driven by a quiet and powerful motor. The condenser draws out excess moisture from the appliance. Condensation and waste water, which result during hydro cooking and cleaning, are continuously drained.

The use of high quality insulation impedes excessive heat radiation and saves energy.

The Hydrovection has optional adjustable legs which adapt easily to slightly uneven surfaces and optional floor stands which are designed for use with all of the table models.

The practical oven doors, with viewing windows, have a wide swing radius and handle which can be operated easily, even with wet or greasy hands.

Ease of operation is guaranteed through the simple arrangement of the controls. Graphic symbols make the appliance easy for even inexperienced kitchen staff to operate. A third function, the Cool Down mode, allows the oven cavity to cool down rapidly with the door opened.

Cleaning is kept to a minimum. The interior is sprayed with a self-acting cleaning solution which interacts with humidity to easily remove crusts and stains. The oven is designed for easy care and is welded water tight so that the internal cooking cavity may be rinsed with a hose after the cleaning process.

PLUMBING SPECIFICATIONS

WATER

Water pressure	30 PSI (207 kPa) minimum 50 PSI (345 kPa) maximum
Water connection	3/4" garden hose - Cold water only
Minimum requirements	TDS: 40-125 ppm Hardness: 35-180 ppm Chlorides: <25 ppm Silica: <13 ppm Chlorine: <0.2 ppm Chloramine: <0.2 ppm pH: 7.0-8.5

DRAINAGE

Drain type	Atmospheric Vented Drain
Drain connection	1.25" O.D.
Maximum water drain temperature	140°F (60°C)

Oven Description & Specifications

RATINGS - HV-100G-AB & HVH-100G-AB					
TYPE OF GAS	GAS INPUT	VOLTAGE	PHASE	AMPS	MOTOR
Natural	60,000 BTU/Hr	115	1	10	3/4 HP 208-240VAC, 3 phase, 50/60 Hz
		208/240	1	5	
Propane	60,000 BTU/Hr	115	1	10	3/4 HP 208-240VAC, 3 phase, 50/60 Hz
		208/240	1	5	

3/4" NPT connector for all U.S. and Canadian installations

RATINGS- HV-100E-AB & HVH-100E-AB							
VOLTAGE	HZ	KW	PHASE	MAX LOAD (AMPS)			MOTOR
				L1	L2	L2	
208	60	15	3	38	38	38	3/4 HP 208-240VAC, 50/60 Hz
240	60	15	3	34	34	34	3/4 HP 208-240VAC, 50/60 Hz
440	60	15	3	20	18	18	3/4 HP 208-240VAC, 50/60 Hz
480	60	15	3	18	17	17	3/4 HP 208-240VAC, 50/60 Hz



Installation

Utility Connections - Standards and Codes

THE INSTALLATION INSTRUCTIONS CONTAINED HEREIN ARE FOR THE USE OF QUALIFIED INSTALLATION AND SERVICE PERSONNEL ONLY. INSTALLATION OR SERVICE BY OTHER THAN QUALIFIED PERSONNEL MAY RESULT IN DAMAGE TO THE OVEN AND/OR INJURY TO THE OPERATOR.

Qualified installation personnel are individuals, a firm, a corporation, or a company which either in person or through a representative are engaged in, and are responsible for:

- The installation or replacement of gas piping. The connection, installation, repair or servicing of equipment.
- The installation of electrical wiring from the electric meter, main control box or service outlet to the electric appliance.

Qualified installation personnel must be experienced in such work, be familiar with all precautions required and have complied with all requirements of state or local authorities having jurisdiction.

U.S. and Canadian Installations

Installation must conform with local codes, or in the absence of local codes, with the National Fuel Gas Code, NFPA54/ANSI Z223.1-Latest Edition, the Natural Gas Installation Code CAN/CGA-B149.1 or the Propane Installation Code, CAN/CGA-B149.2 as applicable.

Reference: National Electrical Code, ANSI/NFPA 70-Latest Edition and/or Canadian Electrical Code CSA C22.1 as applicable.

This equipment is to be installed in compliance with the Basic Plumbing Code of the Building Officials and Code Administrators International Inc. (BOCA) and the Food Service Sanitation Manual of the Food and Drug Administration (FDA).

Appliance is to be installed with backflow prevention in accordance with applicable federal, province and local codes.

General Export Installations

Installation must conform with Local and National installation standards. Local installation codes and/or requirements may vary. If you have any questions regarding the proper installation and/or operation of your appliance, please contact your local distributor. If you do not have a local distributor, please call Blodgett at 0011-802-658-6600.



Oven Location and Ventilation

OWNER'S RESPONSIBILITIES

Installation responsibilities prior to service startup inspection

You are entitled to a free start-up inspection service by our factory ASAP. Before a factory representative arrives to perform a startup procedure, the owner must already have satisfied the following requirements.

- Oven(s) are uncrated, stacked (if applies) and put in place.

NOTE: Please refer to Leg Attachment and Stacking.

Maximum shelf loading - 60 lbs (27.3 Kg)

OVEN LOCATION

The well planned and proper placement of your oven will result in long term operator convenience and satisfactory performance.

Certain minimum clearances must be maintained between the oven and any combustible or non-combustible construction. See the table below.

In addition, the following clearances are recommended for servicing.

- Oven body sides - 12" (30cm)
- Oven body back - 12" (30cm)

OVEN MODEL	MINIMUM REQUIRED CLEARANCES		
	Right Side	Left Side	Back
HV-100E & HVH-100E	0" (0mm)	0" (0mm)	6" (152.4mm)
HV-100G & HVH-100G	0" (0mm)	0" (0mm)	6" (152.4mm)

- Do not place strong sources of heat such as open flame ranges, griddles, or charbroilers near the oven. If such an instance exists, it is highly recommended to purchase a heat shield, available from Blodgett.
- Note that if temperatures are too high, a safety shutdown may occur.
- Failure to comply may invalidate the oven warranty.

VENTILATION

The necessity for a properly designed and installed ventilation system cannot be over emphasized. The ventilation system will allow the unit to function properly while removing unwanted vapors and products of combustion from the operating area.

The appliance must be vented with a properly designed mechanically driven exhaust hood. The hood should be sized to completely cover the equipment plus an overhang of at least 6" (15 cm) on all sides not adjacent to a wall. The capacity of the hood should be sized appropriately and provisions made for adequate makeup air.



WARNING!!

Failure to properly vent the oven can be hazardous to the health of the operator; and will result in operational problems, unsatisfactory baking, and possible damage to the equipment. Damage sustained as a direct result of improper ventilation will not be covered by the Manufacturer's warranty.

When installed in the Commonwealth of Massachusetts, this appliance must be interlocked with the hood exhaust system so that the appliance may be operated only when the hood exhaust system is running.

U.S. and Canadian Installations

Refer to your local ventilation codes. In the absence of local codes, refer to the National ventilation code titled, "Standard for the Installation of Equipment for the Removal of Smoke and Grease Laden Vapors from Commercial Cooking Equipment", NFPA-96- Latest Edition.

General Export Installations

Installation must conform with Local and National installation standards. Local installation codes and/or requirements may vary. If you have any questions regarding the proper installation and/or operation of your unit, please contact your local distributor. If you do not have a local distributor, please call Blodgett at 0011-802-658-6600.



Installation

Leg Attachment

LEG OPTIONS

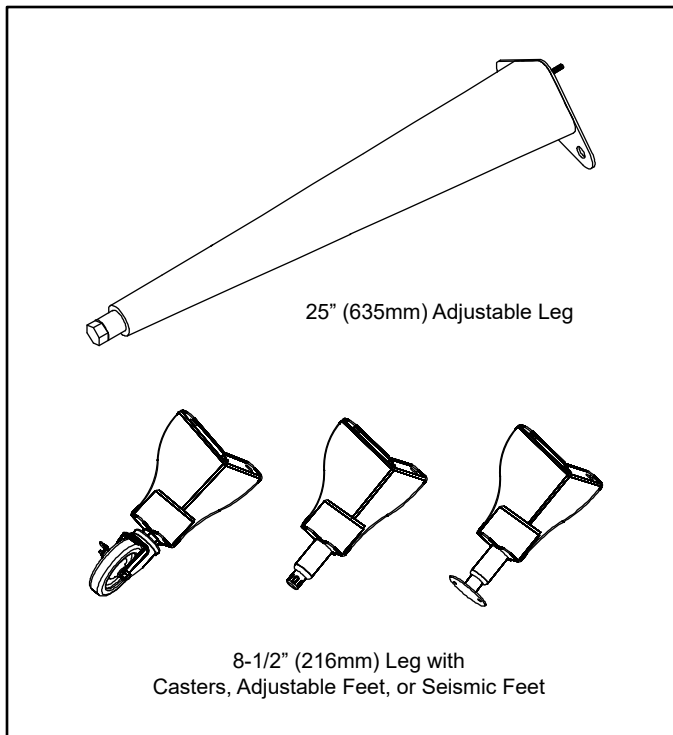

Figure 1

ATTACHMENT

1. Align the threaded stud on one of the front legs to the bolt hole located in the bottom corner of the appliance. Turn the leg clockwise and tighten to the nearest full turn.
2. Align the leg plate holes with the bolt holes. Secure with the two 1/2" bolts provided.
3. Repeat the above steps with the other front leg. If casters are used, install them with the locking casters in the front of the oven. The rear casters do not lock. Ensure that the locks are set on the front casters.
4. Tip the oven up on the newly installed front legs. If casters are used, check that the locks are set on the front casters. Repeat the above steps for the rear legs.
5. Level the oven by screwing the adjustable feet in or out as necessary.

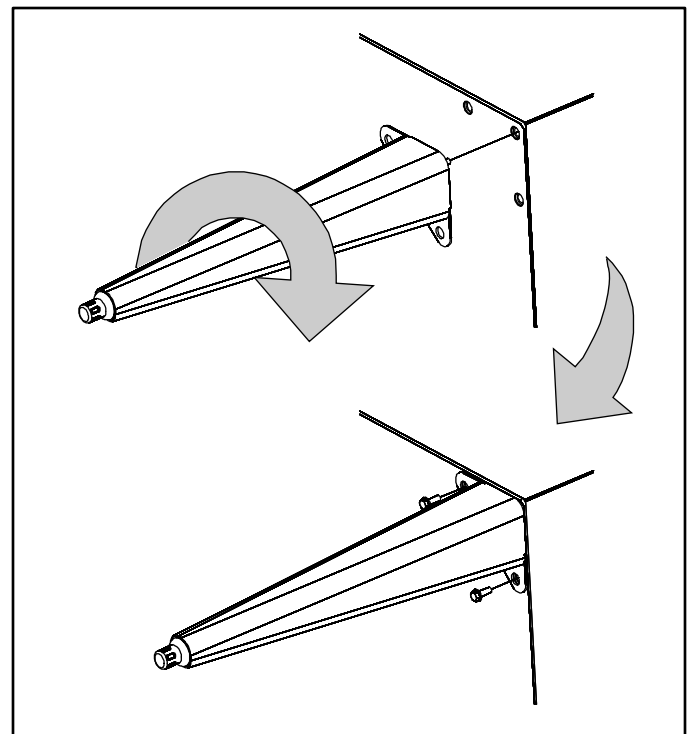

Figure 2

Caster Attachment

CASTERS FOR SINGLE OVENS

1. Attach the legs as described.
2. Pry the adjustable feet out of the legs.
3. Insert one caster into each leg as shown. Tighten the lock nuts to secure the casters.

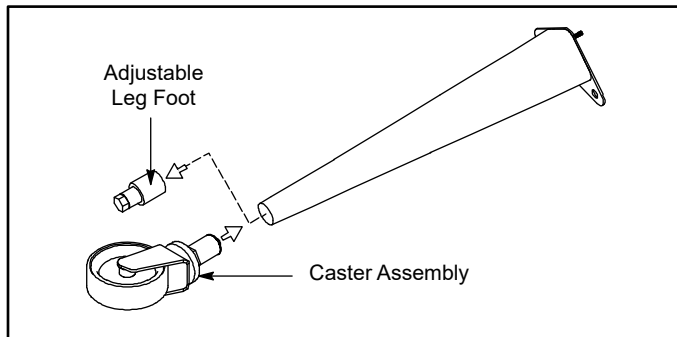

Figure 3

PROFILE CASTERS FOR DOUBLE STACK OVENS

1. Place a level on the floor where the casters are to rest.
2. Place shims under the low side until it is level.
3. Mount the shims between the casters and the oven as follows:
 - a. Align the shims and caster holes with the bolt holes.
 - b. Secure with the 1/2" bolts provided.

NOTE: Install them with the locking casters in the front of the oven. The rear casters do not lock. Ensure that the locks are set on the front casters.

4. Tip the oven up on the newly installed casters.

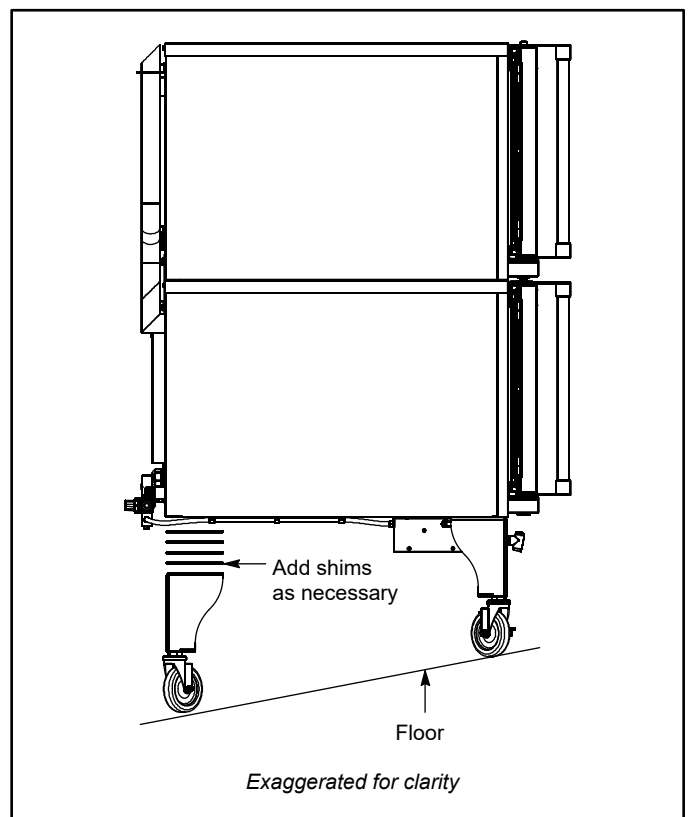

Figure 4



Installation

Stacking



WARNING!!

Stacking should be performed by qualified installation personnel only. The ovens are heavy. Take care to use proper tools and techniques when lifting and stacking units.

1. Attach the legs or casters to the bottom oven.
2. Place the top oven on the bottom oven. Be sure all four sides are flush.
3. Bolt the two ovens together from behind using the stacking brackets.
4. Install the vent riser onto the vent on the right rear of the bottom oven. Use the 4 inch piece of tubing and hose clamps to secure the vent extension to the bottom oven. Install vent extension bracket over both tubes at the top oven. Secure the bracket to the top oven with the screw provided.
5. GAS OVENS ONLY.
 - a. Slide the flue extension over the flue on the bottom oven. Remove the access cover flue trim and replace it with the flue extension bracket. Reinstall the mounting screws.

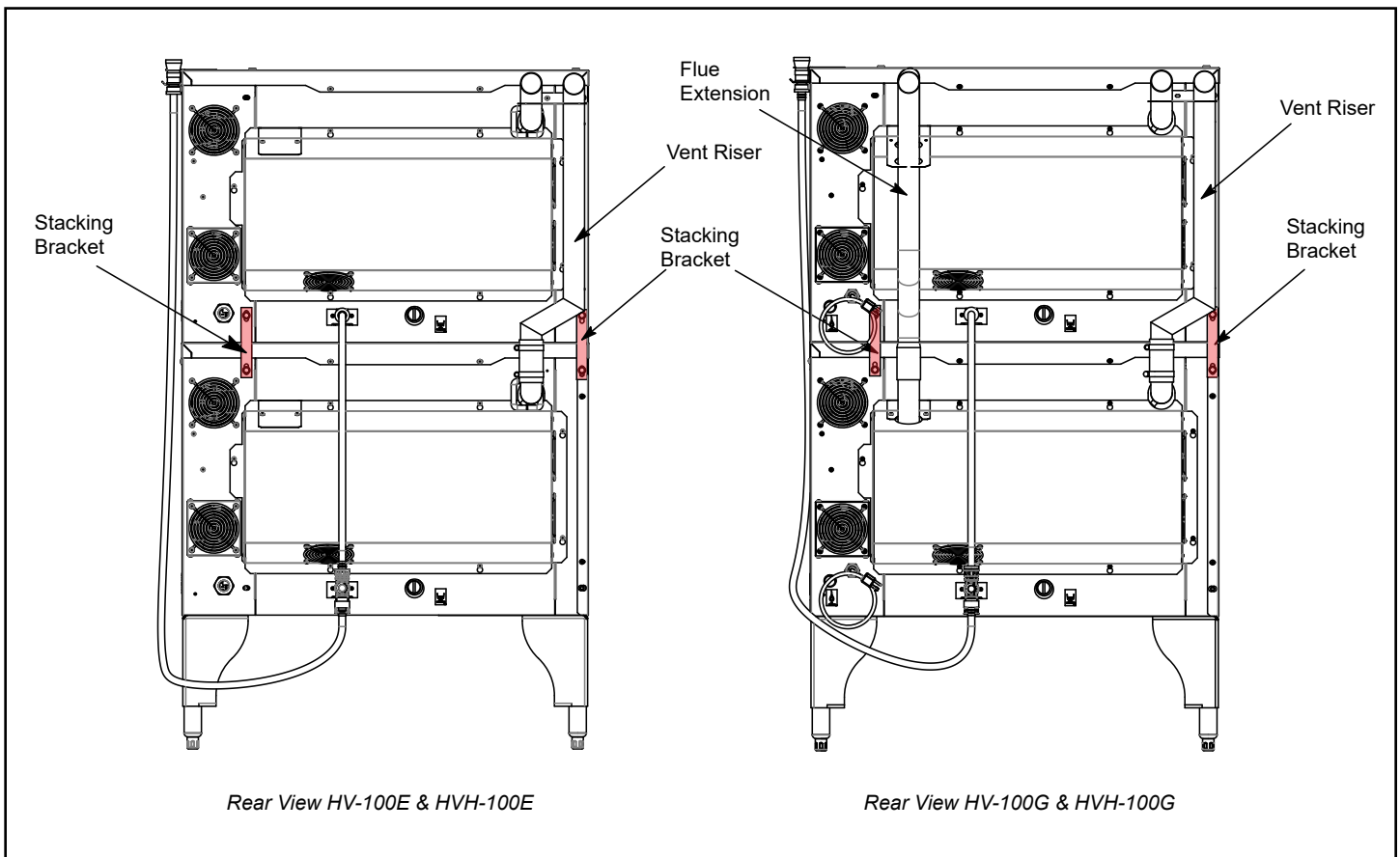

Figure 5

Stacking

GAS OVENS ONLY

1. Slide the flue extension over the flue on the bottom oven. Remove the access cover flue trim and replace it with the flue extension bracket. Reinstall the mounting screws.

The HV100G double stack configuration comes with a manifold kit to connect the two ovens to the same gas source.

Be sure to use pipe thread sealant on all fittings.

1. Install the straight run of the tee on the gas connection of the top oven.
2. Install the straight coupler to the gas connection on the bottom oven.
3. Install one end of the flexible gas hose to the threads perpendicular to the straight run of the tee previously installed, install the other end in the coupler previously installed on the bottom oven.
4. Install the incoming gas line to the straight run of the tee installed on the top oven.
5. Be sure to use a standard leak detection method on newly installed parts after the install before firing the oven for the first time, or when the oven has been disconnected from fuel service.

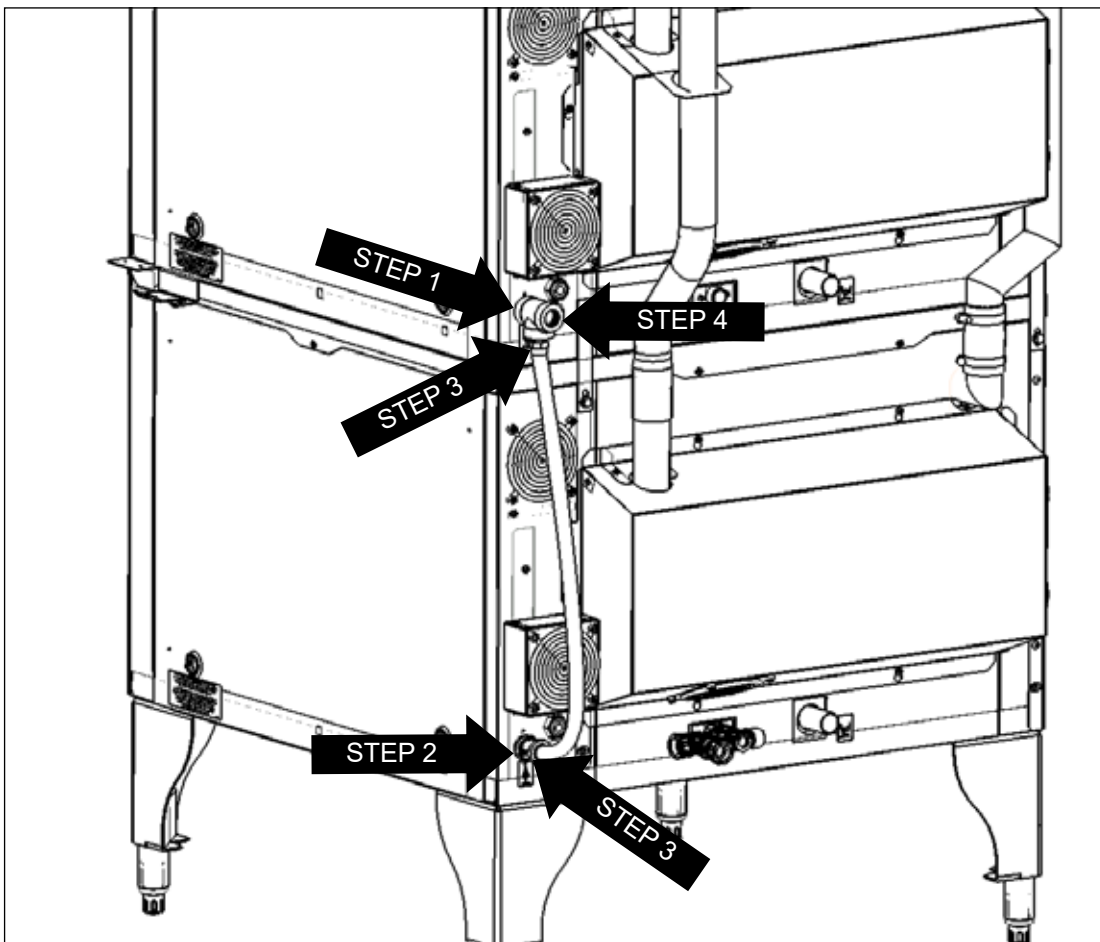

Figure 6



Installation

Plumbing Connections

WATER CONNECTION

NOTE: Must use COLD WATER ONLY.

Connect the appliance to quality water via a pressure hose with 3/4" GHT (19mm) couplings. See figure below for connections. A shut off valve is to be provided adjacent to the oven.



WARNING!!

Operating the appliance without a water pressure regulator installed will invalidate your warranty.

This product must be installed by a licensed Plumber or Gas Fitter when installed within the Commonwealth of Massachusetts.



WARNING!!

The hand shower spray nozzle supplied to wash down the oven interior is NOT lead-free, and not intended for drinking.

DRAIN CONNECTION

The drain should be run to an open floor drain avoiding flexible hose that could sag and allow trapped water to accumulate. The customer must supply the piping from the oven to the drain.

NOTE: The drain piping must consist of temperature resistant material, greater than 160°F, and be of adequate diameter not to cause flow restriction. Improper materials may deform and cause restrictions, thus affecting performance.



WARNING!!

Connection must be carried out by a licensed plumber, to an open or closed drain. The drain must never end directly beneath the equipment. The drain should not be located on the same side the equipment controls are located.

Specific water/drain connection for City of Los Angeles

1. Each drain line from the appliance shall be routed without dips or sags to terminate above the flood level rim of an approved indirect waste receptor.

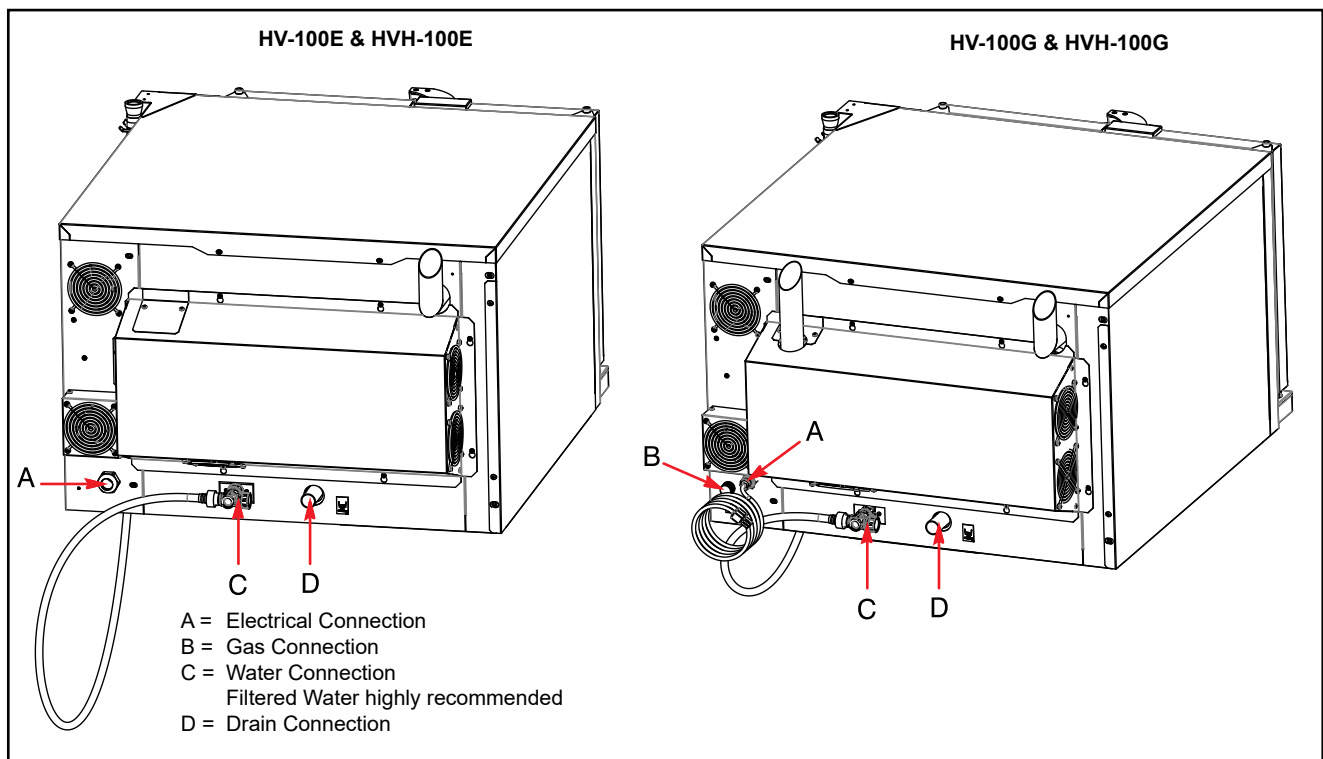

Figure 9



Plumbing Connections

- The appliance shall be installed in accordance with the manufacturer's printed instructions and the LAPC and LAMC, 1999 editions.
- A backflow protection device may be required by local codes. If so, install on the potable water system directly ahead of the appliance. The backflow protection device shall be any of the following: an approved pressure type vacuum breaker installed at least 12" above the highest point of use, a double check valve backflow preventer or a reduced pressure principal backflow preventer.

WATER MANIFOLD FOR HV100-AB ON HV100-AB WITHOUT HAND SHOWER

All HV100 models require a cold water connection, located on the rear of the oven next to the drain.

- Install the water manifold with the center female port threaded into the cold water connection of the lower HV100. Direct the male threads to the control panel side of the oven.
- Install the oven stacking connection hose (provided in the stacking kit) between the remaining female water manifold port and the cold water connection of the top HV100.
- Connect the water source supply line to the male threads of the water manifold. The stacking kit is also supplied with a female/female thread adapter. This may be needed on the male threaded water manifold port if the water source supply line connection is a male thread.

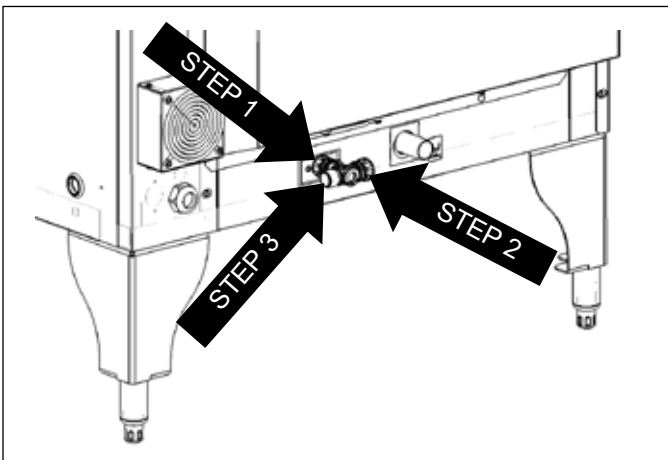

Figure 7

WATER MANIFOLD FOR HV100-AB ON HV100-AB WITH HAND SHOWER

All HV100 models require a cold water connection, located on the rear of the oven next to the drain.



WARNING!!

The hand shower spray nozzle supplied to wash down the oven interior is NOT for use with potable water.

- Install the first water manifold with the center female port threaded into the cold water connection of the lower HV100. Direct the male threads towards the control compartment side.
- Connect the second water manifold to the installed manifold by threading the straight run female port on the second manifold into the male port on the previously installed water manifold.
- Connect the female end of the hand shower hose to the male port of the water manifold facing the control side of the oven.
- Install the oven stacking connection hose (provided in the stacking kit) located between the female water manifold port to the cold water connection on the top HV100.
- Connect the water source supply line to the female threads of the water manifold. The stacking kit is also supplied with a male/male thread adapter. This may be needed if the water source supply line connection is a female thread.

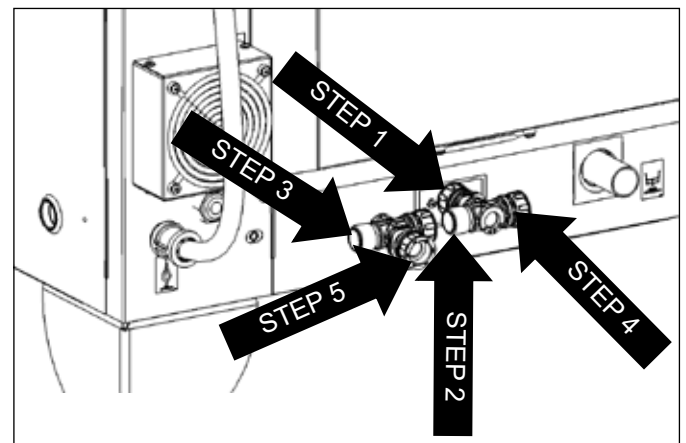

Figure 8



Installation

Electrical Connections

ALL MODELS

NOTE: Electrical connections must be performed by a qualified installer only.

Before making any electrical connections to these appliances, check that the power supply is adequate for the voltage, amperage, and phase requirements stated on the rating name plate mounted on the appliance.

The circuit breaker that is used to provide power to this appliance must have a minimum of .076" (3mm) contact spacing. The circuit breaker must meet all Local and National installation standards.

All appliances must be installed in accordance with Local or National Electrical codes.

This appliance uses a variable frequency drive, which can be known to product high frequency electrical noise. In some cases units must be hard wired. This avoids false positives on ground fault devices susceptible to errors from electrical noise. All installations must comply with local and national codes.

A wiring schematic is located on the inside of the removable side panel.

NOTE: Disconnect the power supply to the appliance before servicing.



WARNING!!

Improper installation may invalidate your warranty.

Electric Models

A strain relief for the power supply cord is provided. The installer must supply a cord that meets all Local and National installation standards.

Gas Models

U.S. and Canadian Installations

A power cord (115V units only) is supplied with a plug attached. Plug the power cord into the desired receptacle.

This oven model uses a variable frequency inverter drive. Appliances that use variable frequency inverter drives produce high frequency noise and require filters and shielded motor cabling. This causes higher leakage current toward Earth Ground. Especially, at the moment of switching ON this can cause an inadvertent trip of the appliance's ground fault interrupter (GFCI). Some GFCIs are more sensitive than others. Blodgett has qualified the Pass and Seymour brand, part number 2095, 20 A, 125 VAC, 60 Hz, specification grade GFCI duplex receptacle as being immune to the variable frequency inverter drive's noise. Blodgett recommends using this specific GFCI for this model oven.



WARNING!!

If the supply cord is damaged, it must be replaced by a special cord or assembly available from the manufacturer or its service agent.

Gas Connection

GAS PIPING

A properly sized gas supply system is essential for maximum oven performance. Piping should be sized to provide a supply of gas sufficient to meet the maximum demand of all appliances on the line without loss of pressure at the equipment.

Example:

NOTE: BTU values in the following example are for natural gas.

You purchase the HV-100G to add to your existing cook line.

1. Add the BTU rating of your current appliances.

Pitco Fryer	120,000 BTU
6 Burner Range	60,000 BTU
Deck Oven	50,000 BTU
Total	230,000 BTU

2. Add the BTU rating of the new oven to the total.

Previous Total	230,000 BTU
HV-100G	60,000 BTU
New Total	290,000 BTU

3. Measure the distance from the gas meter to the cook line. This is the pipe length. Let's say the pipe length is 40' (12.2 m) and the pipe size is 1" (2.54 cm).

4. Use the appropriate table to determine the total capacity of your current gas piping.

The total capacity for this example is 375,000 BTU. Since the total required gas pressure, 290,000 BTU is less than 375,000 BTU, the current gas piping will not have to be increased.

NOTE: The BTU capacities given in the tables are for straight pipe lengths only. Any elbows or other fittings will decrease pipe capacities. Contact your local gas supplier if you have any questions.

Maximum Capacity of Iron Pipe in Cubic Feet of Natural Gas Per Hour

(Pressure drop of 0.5 Inch W.C.)

PIPE LENGTH (FT)	NOMINAL SIZE, INCHES				
	3/4"	1"	1-1/4"	1-1/2"	2"
10	360	680	1400	2100	3950
20	250	465	950	1460	2750
30	200	375	770	1180	2200
40	170	320	660	990	1900
50	151	285	580	900	1680
60	138	260	530	810	1520
70	125	240	490	750	1400
80	118	220	460	690	1300
90	110	205	430	650	1220
100	103	195	400	620	1150

From the National Fuel Gas Code Part 10 Table 10-2

Maximum Capacity of Pipe in Thousands of BTU/hr of Undiluted L.P. Gas at 11" W.C.

(Pressure drop of 0.5 Inch W.C.)

PIPE LENGTH (FT)	OUTSIDE DIAMETER, INCHES		
	3/4"	1"	1-1/2"
10	608	1146	3525
20	418	788	2423
30	336	632	1946
40	287	541	1665
50	255	480	1476
60	231	435	1337
70	215	404	1241
80	198	372	1144
90	187	351	1079
100	175	330	1014

From the National Fuel Gas Code Part 10 Table 10-15



Installation

Gas Connection

PRESSURE REGULATION AND TESTING

The gas pressure to the appliance must be rated for each appliance while the burners are on. A sufficient gas pressure must be present at the inlet to satisfy these conditions. Refer to the table below for correct gas pressure.

Each appliance has been adjusted at the factory to operate with the type of gas specified on the rating plate.

Each oven is supplied with a regulator to maintain the proper gas pressure. The regulator is essential to the proper operation of the oven and should not be removed.

DO NOT INSTALL AN ADDITIONAL REGULATOR WHERE THE UNIT CONNECTS TO THE GAS SUPPLY UNLESS THE INLET PRESSURE IS GREATER THAN 14" W.C. (1/2 PSI) (37mbar).

The oven and its individual shutoff valve must be disconnected from the gas supply piping system during any pressure testing of that system at test pressures in excess of 1/2 psig (3.45kPa).

The oven must be isolated from the gas supply piping system by closing its individual manual shutoff valve during any pressure testing of the gas piping system at test pressures equal or less than 1/2 psig (3.45kPa).

Prior to connecting the appliance, gas lines should be thoroughly purged of all metal filings, shavings, pipe dope, and other debris. After connection, the appliance must be checked for correct gas pressure.

U.S. and Canadian Installations

Installation must conform with local codes, or in the absence of local codes, with the National Fuel Gas Code, NFPA54/ANSI Z223.1-Latest Edition, the Natural Gas Installation Code CAN/CGA-B149.1 or the Propane Installation Code, CAN/CGA-B149.2 as applicable.

General Export Installations

Installation must conform with Local and National installation standards. Local installation codes and/or requirements may vary. If you have any questions regarding the proper installation and/or operation of your appliance, please contact your local distributor. If you do not have a local distributor, please call Blodgett Combi at 0011-802-658-6600.

GAS PRESSURE - HV-100G			
Gas Type	Inlet Pressure	Orifice Size at Sea Level	Manifold Pressure
Natural	7" W.C.	.085" dia	3.5" W.C.
Propane	14" W.C.	.063" dia	10" W.C.

Gas Hose Restraint

If the appliance is mounted on casters, a commercial flexible connector with a minimum of 3/4" (1.9 cm) inside diameter must be used along with a quick connect device.

A restraint must be used to limit the movement of the appliance so that no strain is placed upon the flexible connector. The restraint should be fastened to the base frame of the oven as close to the flexible connector as possible. It should be short enough to prevent any strain on the connector. With the restraint fully stretched the connector should be easy to install and quick connect.

The restraint (ie: heavy gauge cable) should be attached without damaging the building. DO NOT use the gas piping or electrical conduit for the attachment of the permanent end of the restraint! Use anchor bolts in concrete or cement block. On wooden walls, drive hi test wood lag screws into the studs of the wall.

WARNING!!

If the restraint is disconnected for any reason it must be reconnected when the appliance is returned to its original position.

U.S. and Canadian installations

The connector must comply with the Standard for Connectors for Movable Gas Appliances, ANSI Z21.69 or Connectors For Moveable Gas Appliances CAN/CGA-6.16 and a quick disconnect device that complies with the Standard for Quick-Disconnect Devices for Use With Gas Fuel, ANSI Z21.41 or Quick Disconnect For Use With Gas Fuel CAN 1-6.9. Adequate means must be provided to limit the movement of the appliance without depending on the connection and the quick disconnect device or its associated piping.

A drip leg must be used at each appliance. Refer to NFPA54/ANSI Z223.1 - Latest Edition (National Fuel Gas Code) for proper drip leg installation.

General export installations

Installation must conform with Local and National installation standards. Local installation codes and/or requirements may vary. If you have any questions regarding the proper installation and/or operation of your appliance, please contact your local distributor. If you do not have a local distributor, please call Blodgett Combi at 0011-802-658-6600.

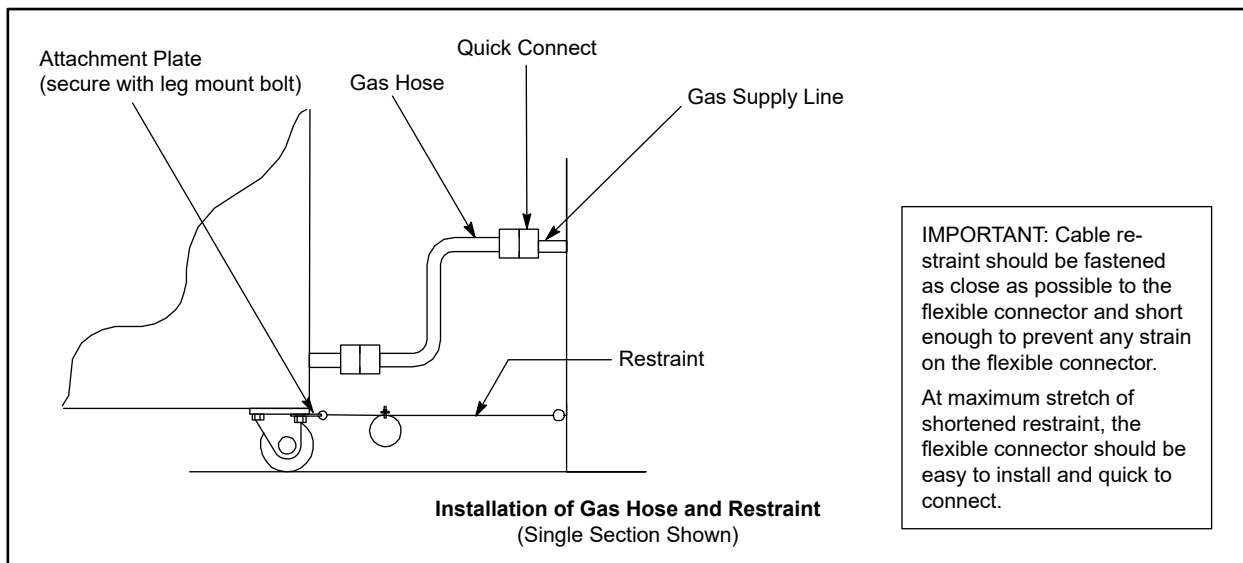

Figure 10



Operation

Safety Information

The information contained in this section is provided for the use of qualified operating personnel. Qualified operating personnel are those who have carefully read the information contained in this manual, are familiar with the functions of the oven and/or have had previous experience with the operation of the equipment described. Adherence to the procedures recommended herein will assure the achievement of optimum performance and long, trouble-free service.

Please take the time to read the following safety and operating instructions. They are the key to the successful operation of your Blodgett oven.



SAFETY TIPS

For your safety read before operating

What to do if you smell gas:

- DO NOT try to light any appliance.
- DO NOT touch any electrical switches.
- Use an exterior phone to call your gas supplier immediately.
- If you cannot reach your gas supplier, call the fire department.

What to do in the event of a power failure:

- Turn all switches to off.
- DO NOT attempt to operate the appliance until the power is restored.

NOTE: In the event of a shut-down of any kind, allow a five (5) minute shut off period before attempting to restart the oven.

General safety tips:

- DO NOT use tools to turn off the gas control. If the gas cannot be turned off manually do not try to repair it. Call a qualified service technician.
- If the oven needs to be moved for any reason, the gas must be turned off and disconnected from the appliance before removing the restraint cable. Reconnect the restraint after the oven has been returned to its original location.
- DO NOT remove the control panel cover unless the oven is unplugged.
- The hand shower spray nozzle supplied to wash down the oven interior is NOT for use with potable water.

Standard Control

NOTE: Not available on HVH-100E and HVH-100G.

CONTROLS IDENTIFICATION

1. POWER KEY - used to place control in and out of standby mode
2. DISPLAY - displays time, temperature, humidity and other information related to oven function and/or programming
3. DISPLAY KEYS - context sensitive keys used to interact with the display
4. HUMIDITY KEY - used to set or change the % of humidity
5. TEMP KEY - used to set or change the bake temperature
6. CONTROL KNOB - used to change values for time, temperature, humidity, etc.
7. TIME KEY - used to set or change the cook time
8. START KEY - press to start the cook cycle
9. VENT KEY - press to manually open and close the vent
10. +1 MINUTE KEY - press at any time to add additional minute to the cook time
11. PROBE KEY - press to use core probe cooking
12. FAN KEY - used to select fan speed
13. HYDRO BURST KEY - press to add 100% humidity at any time during the cook cycle
14. LIGHTS KEY - press to turn the oven lights on and off
15. RECIPES KEY - press to access product programs or to add/edit a product
16. COOL DOWN KEY - initiates oven cool down cycle
17. TOOLS KEY - press to enter manager programming
18. USB PORT AND COVER - used to transfer recipes to and from the control
19. HEAT CUTOFF - used to turn heat source off
20. CIRCUIT BREAKER - Used to turn power to the unit on or off
21. CORE PROBE CONNECTION - plug core temperature probe in here when using probe cooking

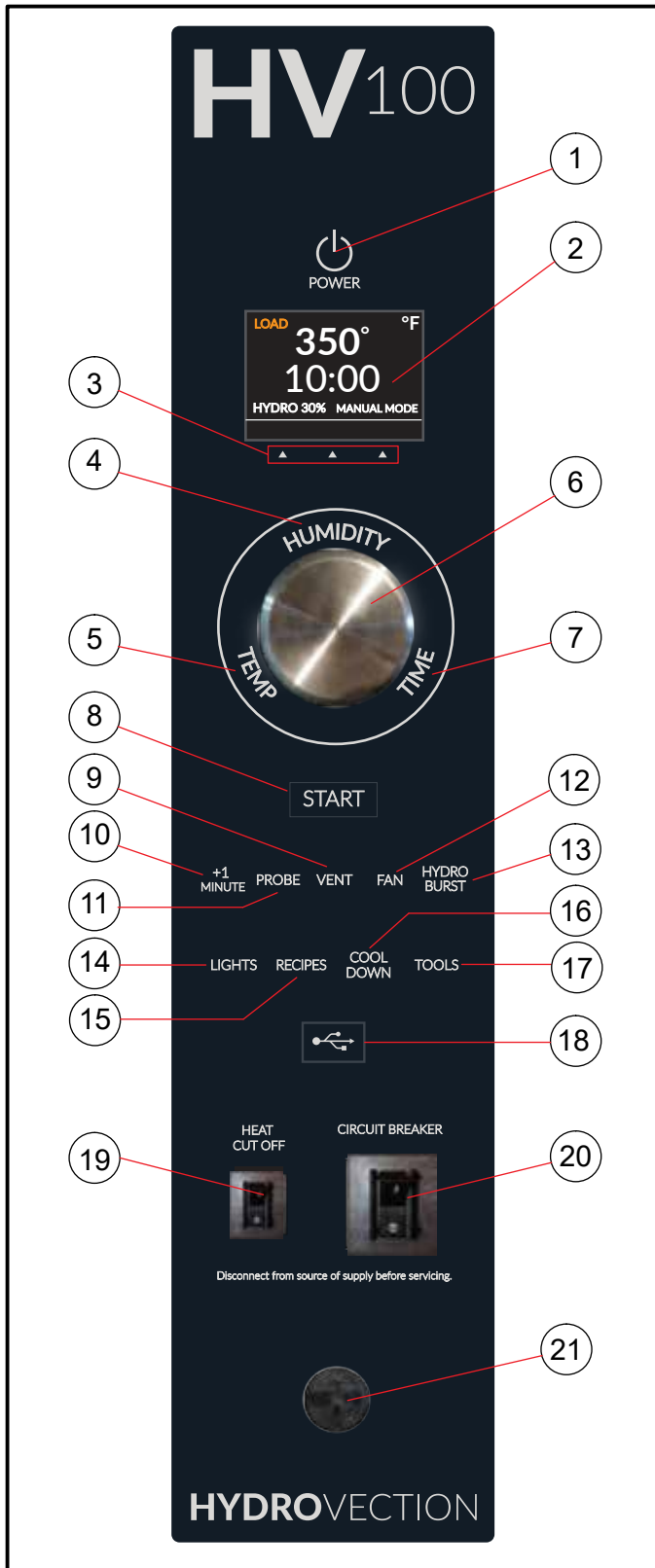



Figure 11



Operation

Standard Control

OVEN STARTUP

1. Be sure the circuit breaker and heat cutoff switches are in the ON position. The display flashes PRESS  POWER KEY TO TURN ON.
2. Press the POWER KEY (1). The display reads “To begin press time/temp/humidity key”. Each key illuminates in succession. Press any key or rotate the knob.
3. The display reads PREHEAT and the oven heats to the last manual set temperature.

The display reads LOAD, the start key flashes and the alarm beeps when the oven is at temperature and ready to bake.

MANUAL COOKING

1. Press the TIME KEY (7). Rotate the CONTROL KNOB (6) to enter the desired cook time. Press any key to accept the value.

*NOTE: Turn the knob slowly to adjust in seconds.
Turn the knob quickly to adjust in minutes.*

2. Press the TEMP KEY (5). Rotate the CONTROL KNOB (6) to enter the desired cook temperature. Press any key to accept the value. The oven preheats to the new set temperature.
3. If humidity is desired, press the HUMIDITY KEY (4). Rotate the CONTROL KNOB (6) to set the desired percentage of humidity. Press any key to accept the value.
4. When the display reads LOAD and the START KEY (8) flashes, open the door and load the product.
5. Press the START KEY (8) to begin the cook cycle. The timer counts down.

NOTE: See page 3 for adjustments that can be made during any cook cycle.

6. When the cook cycle is complete, the alarm beeps and the display reads DONE. Press any key to silence alarm. Select CANCEL using the right display key to exit the cook cycle.
7. Remove the product from the oven.

MANUAL CORE PROBE COOKING

1. Press the PROBE KEY (11). Rotate the CONTROL KNOB (6) to enter the desired product setpoint temperature.
2. Press the TEMP KEY (5). Rotate the CONTROL

KNOB (6) to enter the desired cavity cook temperature. Press any key to accept the value. The oven preheats to the new cavity set temperature.

3. If humidity is desired, press the HUMIDITY KEY (4). Rotate the CONTROL KNOB (6) to set the desired percentage of humidity. Press any key to accept the value.
4. Insert cooking probe into the center of the product. Plug the core probe into the CORE PROBE CONNECTION (21). Load the product into the oven.

NOTE: Pressing the START KEY (8) is not necessary while cooking with the core probe.

NOTE: See page 3 for adjustments that can be made during any cook cycle.

5. When the product has reached the setpoint temperature, the alarm beeps and the display reads DONE. Unplug the core probe to silence the alarm and exit the cook cycle.
6. Remove the product from the oven.

MANUAL CORE PROBE COOK & HOLD

1. Press the PROBE KEY (11). Rotate the CONTROL KNOB (6) to enter the desired product setpoint temperature.
2. Press the center display key under the word HOLD. HOLD will be highlighted in blue indicating that the hold mode is active.
3. Press the TEMP KEY (5). Rotate the CONTROL KNOB (6) to enter the desired cavity cook temperature. Press any key to accept the value. The oven preheats to the new cavity set temperature.
4. If humidity is desired, press the HUMIDITY KEY (4). Rotate the CONTROL KNOB (6) to set the desired percentage of humidity. Press any key to accept the value.
5. Insert cooking probe into the center of the product. Plus the core probe into the CORE PROBE CONNECTION (21).

NOTE: Pressing the START KEY (8) is not necessary while cooking with the core probe.

NOTE: See page 3 for adjustments that can be made during any cook cycle.

As the product temperature rises, the oven cavity temperature decreases.

6. When the product reaches the setpoint temperature,

7. a short alarm sounds. The cavity temperature jumps to 4°F above the product setpoint. This temperature will hold the product, keeping it warm without continuing the cooking process.

The display counts up the time the product has been holding.

8. Unplug the core probe to remove the product from the oven.

PROGRAMMED COOKING

1. Press the RECIPES KEY (15). The display lists all of the currently programmed recipes. Rotate the knob until the desired product recipe is highlighted. Press OK using the right display key to select the product.
2. The oven preheats to the set temperature. When the display flashes LOAD, open the door and load the product.
3. Press the START KEY (8) to begin the cook cycle. The timer counts down.

NOTE: See page 19 for adjustments that can be made during any cook cycle.

4. When the cook cycle is complete, the alarm beeps and the display reads DONE. Press any key to silence alarm. Select CANCEL using the right display key to exit the cook cycle.
5. Remove the product from the oven.

COOK CYCLE ADJUSTMENTS

The following adjustments can be made at any time during the cook cycle.

Vent Moisture from the Oven Cavity

1. Press the VENT KEY (9). This manually opens the vent until the key is pressed again to close it.

Cancel a Cook Cycle

1. To cancel the cook cycle, press the right display key under the word cancel.

Hydro Burst

1. To add 100% humidity at any time during a cook cycle, press the HYDRO BURST KEY (13).
2. Rotate the knob to enter the length of time you wish to inject the moisture.
3. Select OK to start injecting humidity.

Adding Time

1. Press the +1 MINUTE KEY (10). One minute is added to the timer for each time the key is pressed.

Fan Adjustments

1. Press the FAN KEY (12). Rotate the knob to select between four fan speeds (gentle, low, high and turbo). Press OK to select the desired fan speed.
2. Select FAN DELAY using the center display key. Rotate the knob to enter the desired fan delay. Select OK to save the fan delay increment.
3. Select FAN REV using the left display key. Rotate the knob to enter the desired length of time between fan reversals. Press OK to save the reversal increment.

COOL DOWN

NOTE: The unit can be cooled down rapidly for steaming, cleaning, etc.

1. To cool down the oven cavity, open the door and press the COOL DOWN KEY(16) and open the door.
2. The oven automatically shuts down when the oven reaches the cool down temperature.

OVEN SHUTDOWN

1. Press the COOL DOWN KEY (16). The display reads COOLING and gives the actual cavity temperature. To speed up the cool down process, open the doors.
2. When the oven has cooled down, the display reads OFF PRESS POWER KEY TO TURN ON.

NOTE: The lights shut off and the vent closed automatically at the end of the cool down cycle.



Operation

Standard Control

PROGRAMMING A RECIPE

NOTE: The control can hold 100 recipes. Each recipe may have up to 10 cooking stages.

1. Press the RECIPES KEY (15). Rotate the knob to select NEW from the bottom of the recipe list.
2. Select EDIT using the left display key. A touchscreen keyboard is displayed. Use the keyboard to enter the desired recipe name.

NOTE: Product names may be up to 15 characters long and can contain letters, numbers, spaces and special characters.

Select OK to save the product name.

3. The control displays a set of default parameters for the first cooking stage. Select EDIT using the left display key to change these parameters.
4. Press the parameter you wish to change. Rotate the knob to the desired value. Select OK to save the new value.
5. Repeat step 4 for each parameter you wish to change.

To program a probe cooking stage:

- b. Press the PROBE/TIME parameter to toggle to Probe.
 - c. Rotate the knob to select the desired product set-point temperature. Select OK to save the temperature.
 - d. Rotate the knob to highlight the probe step in the step list. The hold toggle appears in the upper left corner of the screen. Rotate the knob to highlight the word HOLD. Select EDIT using the left display key to toggle between YES and NO.
6. To add a cooking step, select ADD using the right display key. The first step is copied. Repeat #5 to set parameters for the new step.
 7. To delete any step, rotate the knob to highlight the step. Select DEL RECIPE using the right display key.
 8. To save the recipe and exit the edit mode, select ESC using the center display key.
 9. To delete a recipe, with the recipe name highlighted during the edit process, press and hold the left display key until the display returns to the recipe list. The recipe will now be deleted from the list.

USING THE MANAGER TOOLS

The manager level screens provide tools to set the time and date, adjust the volume of the beeper and upload/download recipes using the USB port.

To access the manager level screens:

1. Press the TOOLS KEY (17).
2. Rotate the knob to select MANAGER. Select OK using the right display key.
3. Use the keypad to enter the code 6647.

USING THE USB PORT

1. From the manager level screens, rotate the knob to scroll to USB. Select OK using the right display key.
2. Rotate the knob to highlight either "Store menu to USB" or "Load menu from USB". Select OK using the right display key.

Store menu to the USB

1. Use the keypad to enter a new filename. Select OK using the right display key.
2. Once upload is complete, press ESCAPE to return to the previous screen.

Load menu from USB

1. Rotate the knob to select the desired file for download. Select OK using the right display key.
2. Once download is complete, press ESCAPE to return to the previous screen.

SmartTouch 2 Touchscreen Control

CONTROL DESCRIPTION

1. TOUCHSCREEN - interactive display for oven functioning and/or programming
2. USB Port and COVER - Use to transfer recipes and data to/from the control
3. HEAT CUTOFF - used to turn heat source off
4. CIRCUIT BREAKER - Provides circuit protection for the oven controls. DO NOT use as a power switch.
5. CORE PROBE CONNECTION - plug core temperature probe in here when using probe cooking



Figure 12



Operation

SmartTouch 2 Touchscreen Control

MANUAL MODE COOKING

1. Press POWER to turn on the oven.
2. Press MANUAL to proceed to the manual cook screen.
3. Set the following cooking parameters from the MANUAL screen.

Humidity - Use the slider at the top of screen to adjust cavity moisture content in 5% increments. To enter an exact value, press and hold the slider until the keypad is displayed. Press ENTER to save.

Temperature - Press the temperature text and enter the desired oven temperature on the keypad provided. Press ENTER to save.

Cook Time - Press the time text and enter the desired cook time on the keypad provided. Press ENTER to save. Press the units text to toggle between hours/minutes and minutes/seconds.

Fan Speed - Press the fan speed text to toggle between Gentle, Low, High or Turbo.

NOTE: If the oven is preheating or cooling down, the fan speed will automatically run in high until the oven reaches the set temperature.

4. Press the FLYOUT MENU arrow to access the following parameters.

Actual Temp - Press to display the actual cavity temperature

Core Probe Cooking - Press to use the core probe cooking feature.

Add a Minute - Press +1 MIN to add 1 minute of time at any point during the cook cycle.

Hydro Burst - Press to add 100% humidity at any time. Use the provided keypad to enter desired length of hydro burst. Press ENTER to save. The display counts down the hydro burst time remaining.

Vent Position - The vent can be opened or closed by toggling the VENT icon at any point during the cook cycle.

NOTE: When vent is opened on HVH models, air is actively forced through the system. This allows for the rapid evacuation of moisture from the cavity.

Fan Delay - Press the fan delay icon. Use the provided keypad to enter a fan delay increment. Press ENTER to save.

Fan Reversal Interval - To adjust the fan reversal time, press the FAN REVERSAL icon. Enter the de-

sired reversal interval on the keypad provided. Press ENTER to save.

Lights - At any time the lights can be turned on or off by toggling the LIGHT icon.

5. The oven preheats to the set temperature.

NOTE: START will not be displayed until the oven has reached the set temperature.

6. Press START to begin cooking. The display counts down. Press CANCEL at any time to stop the cook cycle.
7. When the cook time has expired, the display flashes DONE and the alarm sounds. Press CANCEL to silence the alarm. The display returns to the previous cook time setting.
8. Press BACK to exit out of MANUAL mode.

CORE PROBE COOKING

1. Press POWER to turn on the oven.
2. Press MANUAL to proceed to the manual cook screen. Set the desired humidity, cook temp and fan speed.
3. Select Core Probe Cooking from the flyout menu.
4. Press the probe target text. Enter the desired finished product temperature on the keypad provided. Press ENTER to save.
5. Insert a core probe into the probe outlet on the control panel.
6. The HOLD button appears. To enable the Cook & Hold feature, press the hold button.
7. When the product has reached the set core temperature the display reads DONE.
8. **Cook Only** - Unplug the core probe and remove the product.

Cook & Hold - The oven cavity temperature adjusts to the optimum temperature for holding the product without overcooking. The display counts up the time the item has been holding.



SmartTouch 2 Touchscreen Control

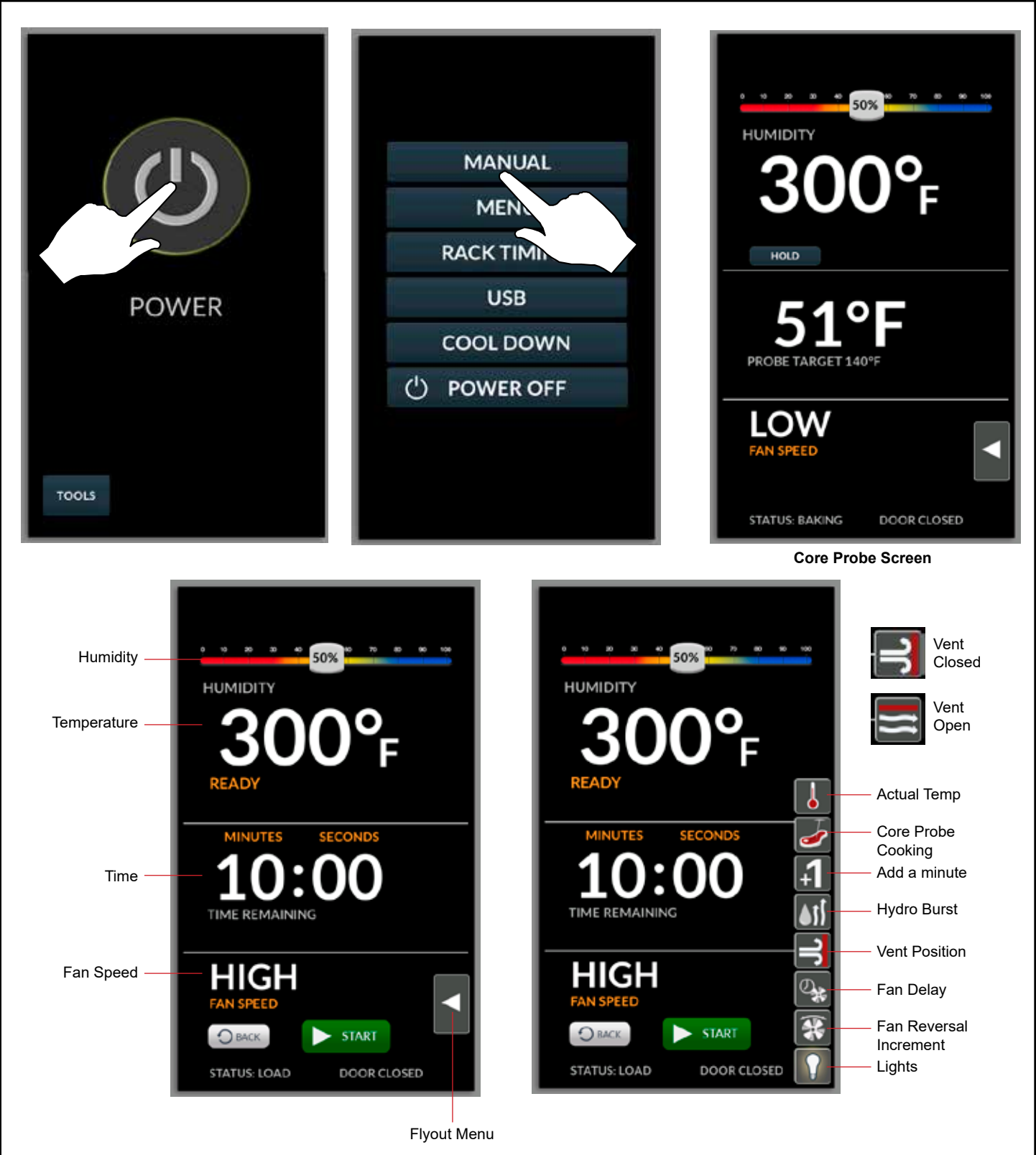

Figure 13



Operation

SmartTouch 2 Touchscreen Control

MENU MODE

Create a New Recipe

1. From the mode selection screen, select MENU.



Figure 14

3. The NEW RECIPE screen is displayed. Press the camera icon.

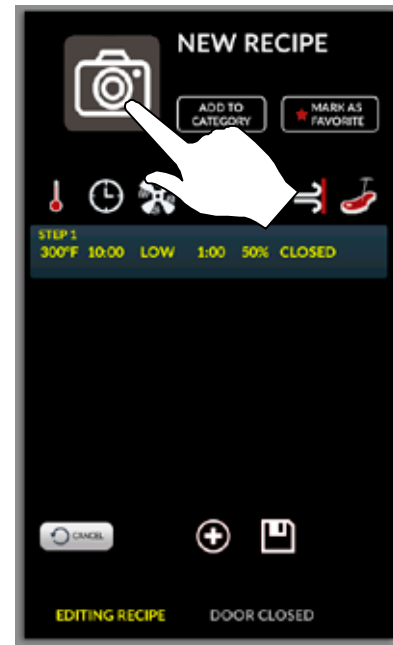

Figure 16

2. Press NEW RECIPE.



Figure 15

4. Select an icon to represent the recipe.



Figure 17

SmartTouch 2 Touchscreen Control

5. Press NEW RECIPE text. Use the keypad provided to enter a recipe name. Press the DISK ICON to save.

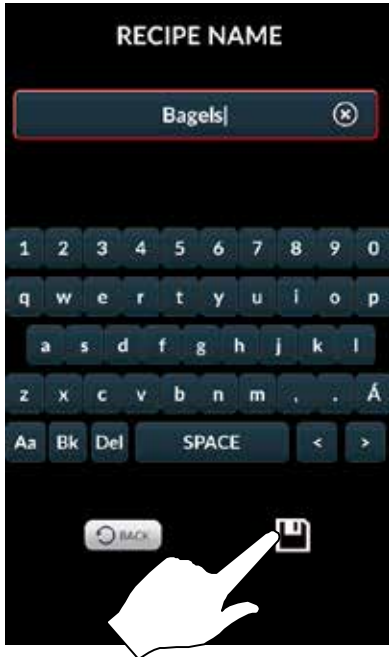

Figure 18

6. OPTIONAL: Press MARK AS FAVORITE if desired.
7. OPTIONAL: To add to an existing category, press ADD TO CATEGORY. Select category. Press DONE.



Figure 19

8. Enter parameters for the first cooking step. Press the icon above each parameter to adjust settings. Press the + to add a step. Press the X to delete the current step.

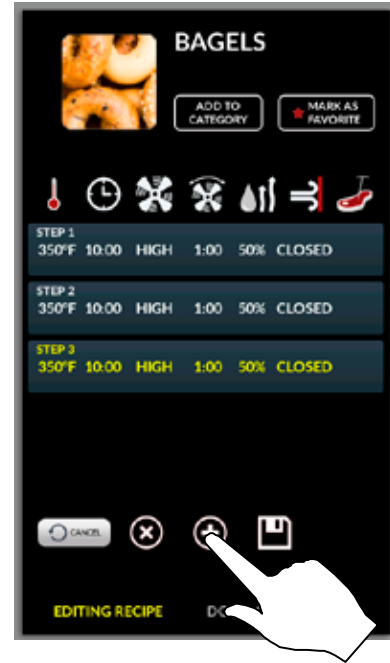

Figure 20

9. Once all steps have been entered, press the DISK ICON to save the recipe

Edit an Existing Recipe

1. From the mode selection screen, select MENU.
2. Press and hold the icon for the recipe you wish to edit.
3. Choose edit, copy or delete from the pop up menu.

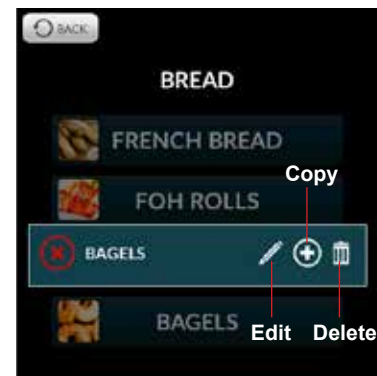

Figure 21



Operation

SmartTouch 2 Touchscreen Control

Create a New Category

1. From the mode selection screen, select MENU.



Figure 22

2. Press NEW CATEGORY.

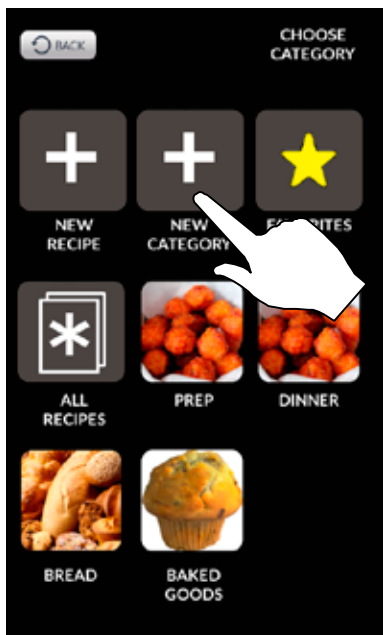

Figure 23

3. Press the camera to select an icon to represent the group.

4. Press the NEW CATEGORY text. Use the keypad provided to enter a category name. Press the DISK ICON to save.

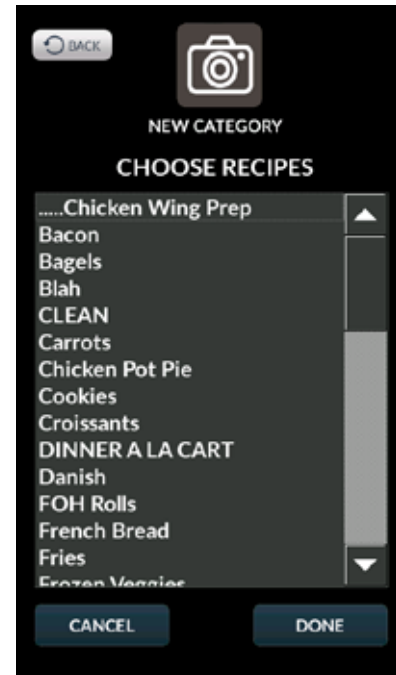

Figure 24

5. Select the recipes to include in the category. Press DONE to save.

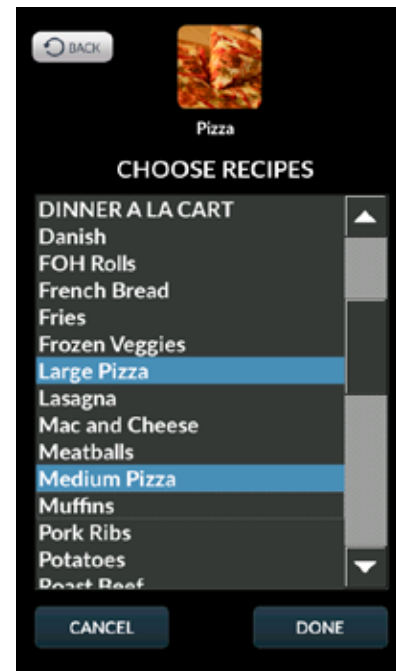

Figure 25



SmartTouch 2 Touchscreen Control

Edit Existing Category

1. From the mode selection screen, select MENU.
2. Press and hold the icon for the category you wish to edit.
3. Choose edit, copy or delete from the pop up menu.

Menu Mode Cooking

1. From the mode selection screen, press MENU.
2. Select a recipe using one of the following:
 - a. If the recipe is one of your favorites, press FAVORITES. Then select the recipe.
 - b. If the recipe is part of a category, select the category. Then select the recipe.
 - c. Press ALL RECIPES, scroll through the list using the left and right arrow keys. Select the recipe.



Figure 26

3. The control enters the Menu Cooking screen. Press the START KEY to begin the cook cycle.

NOTE: START will not be displayed until the oven has reached the programmed set temperature.

NOTE: If the oven is preheating or cooling down, the fan speed will automatically run in high until the oven reaches the set temperature.

NOTE: To edit a cooking step, press and hold the step before starting the program.

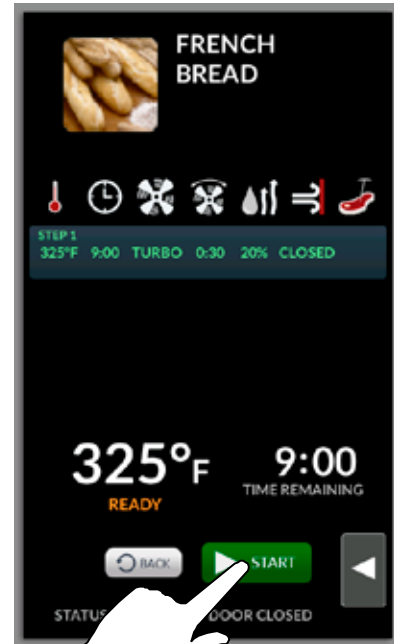

Figure 27

4. Press the FLYOUT arrow at any time to access Add a Minute, Hydro Burst or the cavity lights. Press CANCEL at any time to stop the cook cycle.

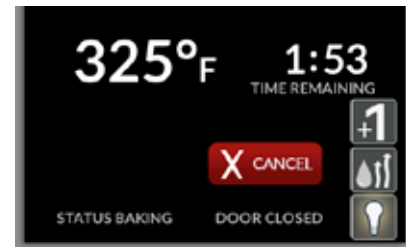

Figure 28

5. When the cook time has expired, the display flashes DONE and the alarm sounds. Press CANCEL to silence the alarm. The control returns to the recipe cook screen.
6. Press BACK to exit out of MENU mode.



Operation

SmartTouch 2 Touchscreen Control

RACK TIMING

Creating a Rack Timing Group

1. From the mode selection screen, select RACK TIMING. The SELECT GROUP screen is displayed.
2. Select ADD GROUP.

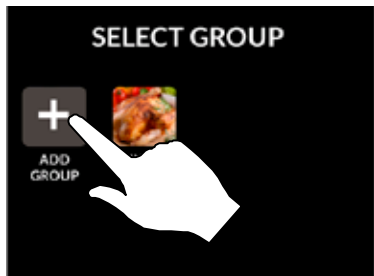

Figure 29

3. Press the pencil icons to edit the group name and cooking parameters. You may also select an icon to represent the group.
4. Enter desired cooking parameters.

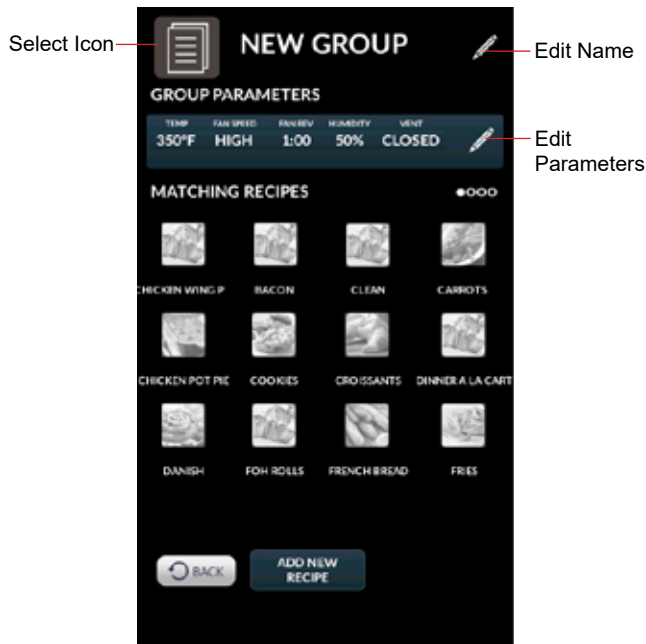

Figure 30

5. Select the recipes you would like to place in the group. Only recipes with parameters matching the group may be selected.

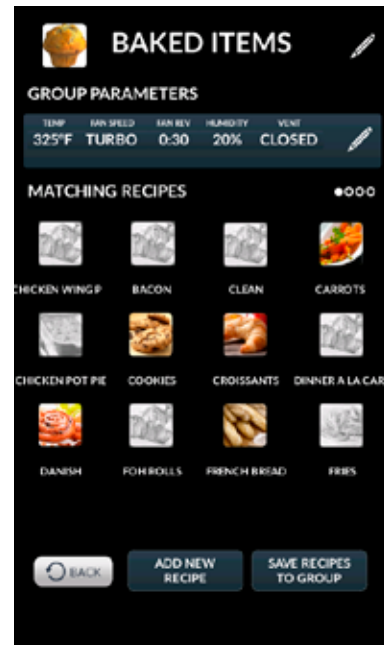

Figure 31

6. Press SAVE RECIPES TO GROUP.

Edit Existing Group

1. From the mode selection screen, select RACK TIMING.
2. Press and hold the icon for the group you wish to edit.
3. Choose edit, copy or delete from the pop up menu.

SmartTouch 2 Touchscreen Control

Using Rack Timing

1. From the mode selection screen, select RACK TIMING. The SELECT GROUP screen is displayed.
2. Select the desired food group for your product.

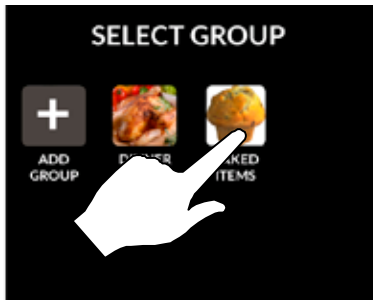

Figure 32

3. Press selected item icon at the top of the screen, drag to an open shelf. Or tap an open rack to assign the selected icon to that rack.

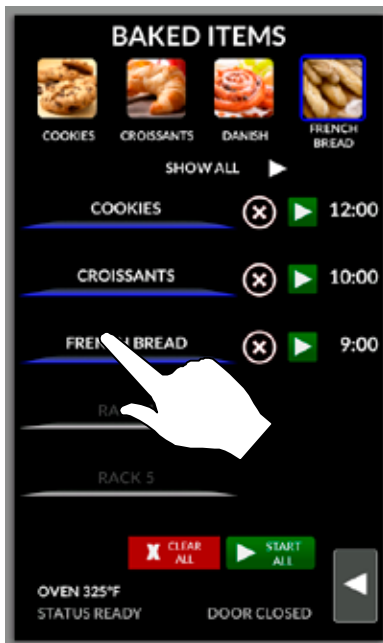

Figure 33

4. Start timers using the arrows. You can choose START ALL or start individual racks.

NOTE: START will not be displayed until the oven has reached the programmed set temperature.

NOTE: If the oven is preheating or cooling down, the fan speed will automatically run in high until the oven reaches the set temperature.

5. To add time, select +1 MIN key for individual racks or +1 MIN ALL key to add time to all racks. Each time the key is pressed, 1 minute of cook time is added.

During the cook cycle, individual rack timers will count down as the product is cooked. If you wish to cancel the bake, you can press the STOP ALL key, or you can stop individual racks.

6. Once a rack bake is complete the beeper will sound. Press STOP next to the rack that has completed the cook cycle. If all racks finish at the same time, press STOP ALL. STOP ALL.

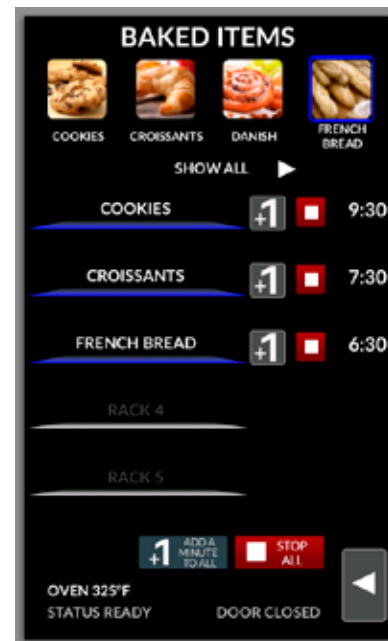

Figure 34

7. Press CLEAR ALL to escape the screen.

To Use Independant Timer

1. Press the FLYOUT arrow at any time to access an independant timer or the cavity lights.



Figure 35



Operation

SmartTouch 2 Touchscreen Control

USB INTERFACE

To Access the USB Drive

1. From the mode selection screen, select USB



Figure 36

2. Enter the code 6647 on the keypad provided.



Figure 37

3. The following menu is displayed.

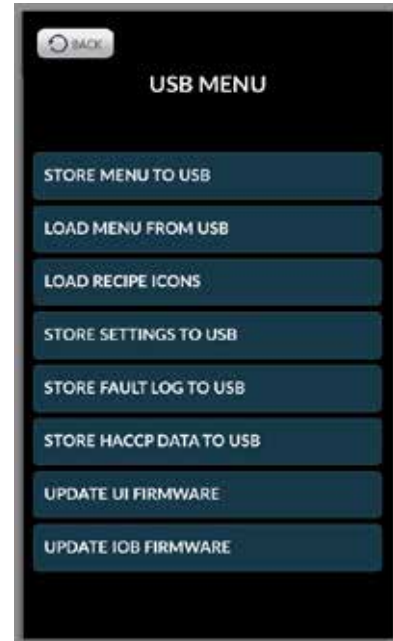

Figure 38

4. Insert USB drive into USB port on the control panel.

SmartTouch 2 Touchscreen Control

To Store Menu Data to a USB

NOTE: The following procedure may be used to store any type of data to a USB including HACCP, settings and fault logs.

1. Select STORE MENU TO USB.
2. Enter a filename for the menu data using the keypad provided. Press the disk icon to save.

NOTE: DO NOT use spaces in the filename.



Figure 39

3. The status screen is displayed. Press OK when the transfer is complete.

To Retrieve Menu Data from a USB

NOTE: The following procedure may be used to upload menu recipes and/or icons from a USB.

1. Select LOAD MENU FROM USB.
2. Select the file to download to the oven.



Figure 40

3. The status screen is displayed. Press OK when the transfer is complete.



Operation

SmartTouch 2 Touchscreen Control

COOL DOWN

1. From the mode selection screen, select COOL DOWN.



Figure 41

2. The display toggles between cooling and open door in yellow until the oven is cool.

NOTE: If the oven is shut down with the circuit breaker switch at the bottom of the front panel, the display will return to the power screen.

NOTE: The vent will automatically open and the fan will run on high speed during cool down to assist in lowering the cavity temperature. The fan and vent will disengage when the oven had cooled.

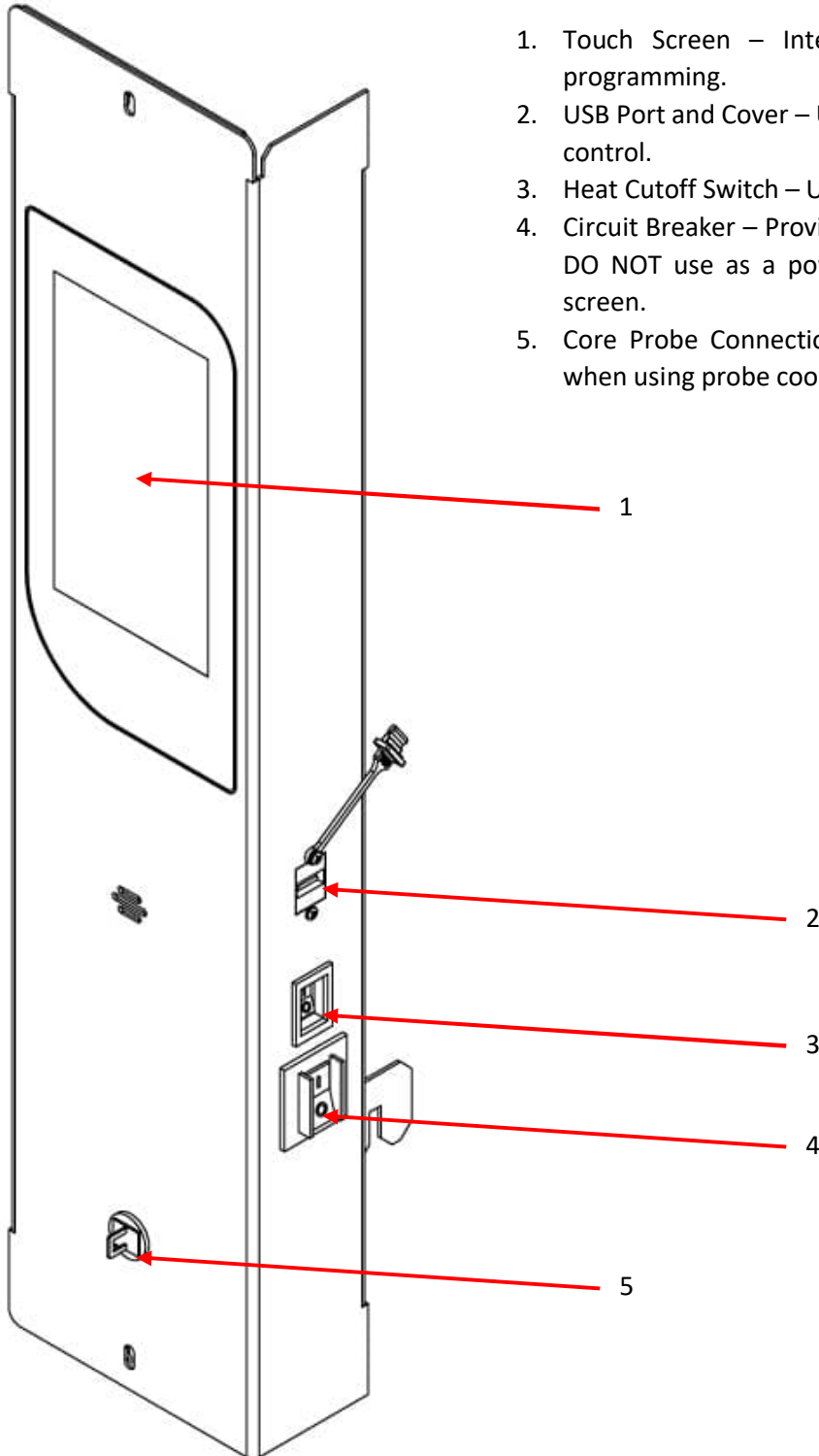

Figure 42

One Touch Touchscreen Control

Blodgett "One Touch" Control Description

1. Touch Screen – Interactive display for oven operation and programming.
2. USB Port and Cover – Use to transfer recipes and data to/from the control.
3. Heat Cutoff Switch – Use to turn heat source off.
4. Circuit Breaker – Provides circuit protection for the oven controls. DO NOT use as a power switch. See page 4 for example "Off" screen.
5. Core Probe Connection – Plug core temperature probe in here when using probe cooking.





Operation

One Touch Touchscreen Control



MANUAL MODE COOKING



1. Touch the screen saver to access the Main home screen.

Note: The oven is "Off" when the Blodgett screen saver is displayed.

2. Touch MANUAL COOKING to proceed to the manual cook screen.
3. Set the following cooking parameters from the MANUAL screen:

 **Temperature** - Touch the temperature text and enter the desired oven temperature on the keypad provided. Press → to save.

 **Cook Time** - Touch the timer text and enter the desired cook time on the keypad provided. Touch → to save. Use the  key to select desired timer. (Timer, Continuous Timer, A La Carte)

 **Core Probe Cooking** – Touch  to use the core probe cooking feature instead of the timer. (See "Core probe cooking" for more info)

 **Humidity** – Touch the humidity text and enter desired level to adjust cavity moisture content. Press → to save.

 **Fan Speed** - Touch the fan speed text to select between Gentle, Low, High or Turbo.

NOTE: If the oven is preheating or cooling down, the fan speed will automatically run in high until the oven reaches the set temperature.

 **Vent Position** - The vent can be toggled open or closed by toggling the **Vent Position** icon at the beginning or at any point during the cook cycle.

NOTE: When vent is opened on HVH models, air is actively forced through the system. This allows for the rapid evacuation of moisture from the cavity.



 **Fan Reversal Interval** - To adjust the fan reversal time, touch the **Fan Reversal** icon. Enter the desired reversal interval on the keypad provided. Press → to save. The default reversal is 6 minutes.

 **Hydro Burst** - Touch to add 100% humidity at any time. Use the provided menu to select desired length of hydro burst. The display counts down the hydro burst time remaining.

 **Lights** - At any time the lights can be toggled on or off by touching the **Light** icon.

4. The oven preheats to the set temperature. The user can load the product and set the timer. Cooking parameters can be changed at any point during the cook and the timer will stay active unless a new time is entered on the timer.
5. Once a timer has been entered the oven will begin cooking.
+/- 1 Minute – While cooking, press +1 min or -1 min to add or subtract 1 minute of cook time at any point.
6. When the cook timer has expired, the display flashes **DONE** and the alarm sounds. Touch anywhere to silence the alarm and return to the previous cooking parameters screen.
7. Touch the back arrow in the top left corner of the screen to exit out of MANUAL COOKING mode.

CORE PROBE COOKING

1. Touch the screen saver to access the Main home screen.
Note: The oven is “Off” when the Blodgett screen saver is displayed.
2. Touch MANUAL COOKING to proceed to the manual cook screen.
3. Insert the core probe into the probe outlet on the control panel. The probe cook symbol can now be selected, touch the  in the timer selection box to enter core probe cooking mode.
8. Touch the probe target temperature text. Enter the desired finished product temperature on the keypad provided. Touch → to save.
9. To access other core probe functions, touch the  key and select the desired function from the list.

Normal – For a normal core probe cook, enter a cavity set temp, and a target product temp. The oven will remain in the cook cycle until the product temp has reached the target temperature.

Cook and Hold – For a Cook and Hold, enter a cavity set temperature and a product target temperature. As the product temperature increases, the cavity set temp will decrease. When product has reached its target temperature, the cavity temperature will be equivalent to the finished product temperature. This allows the finished product to be held in the cavity without overcooking.

Delta T – For a delta-T cook, enter a target product temperature. The oven will calculate the cavity set temperature based on the product temperature. As the product temperature increases the cavity set temperature will also increase until the product target temperature is reached.

Note: Disable pre-heat lockout in the general oven settings to properly access Delta T.

10. When the product has reached the set core temperature the display will read DONE.
11. Unplug the core probe and remove the product.

A-La-Carte COOKING

1. Select the “A La Carte” function from the cook timer menu shown below to access manual cooking with multiple timers.

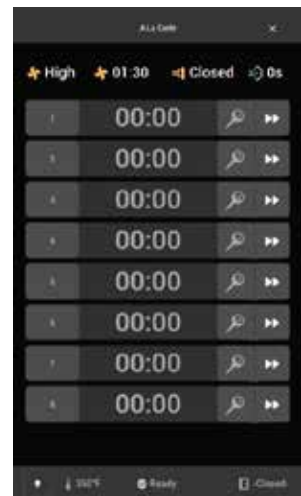

NOTE: The number of rack timers is configurable in settings.



Operation

One Touch Touchscreen Control

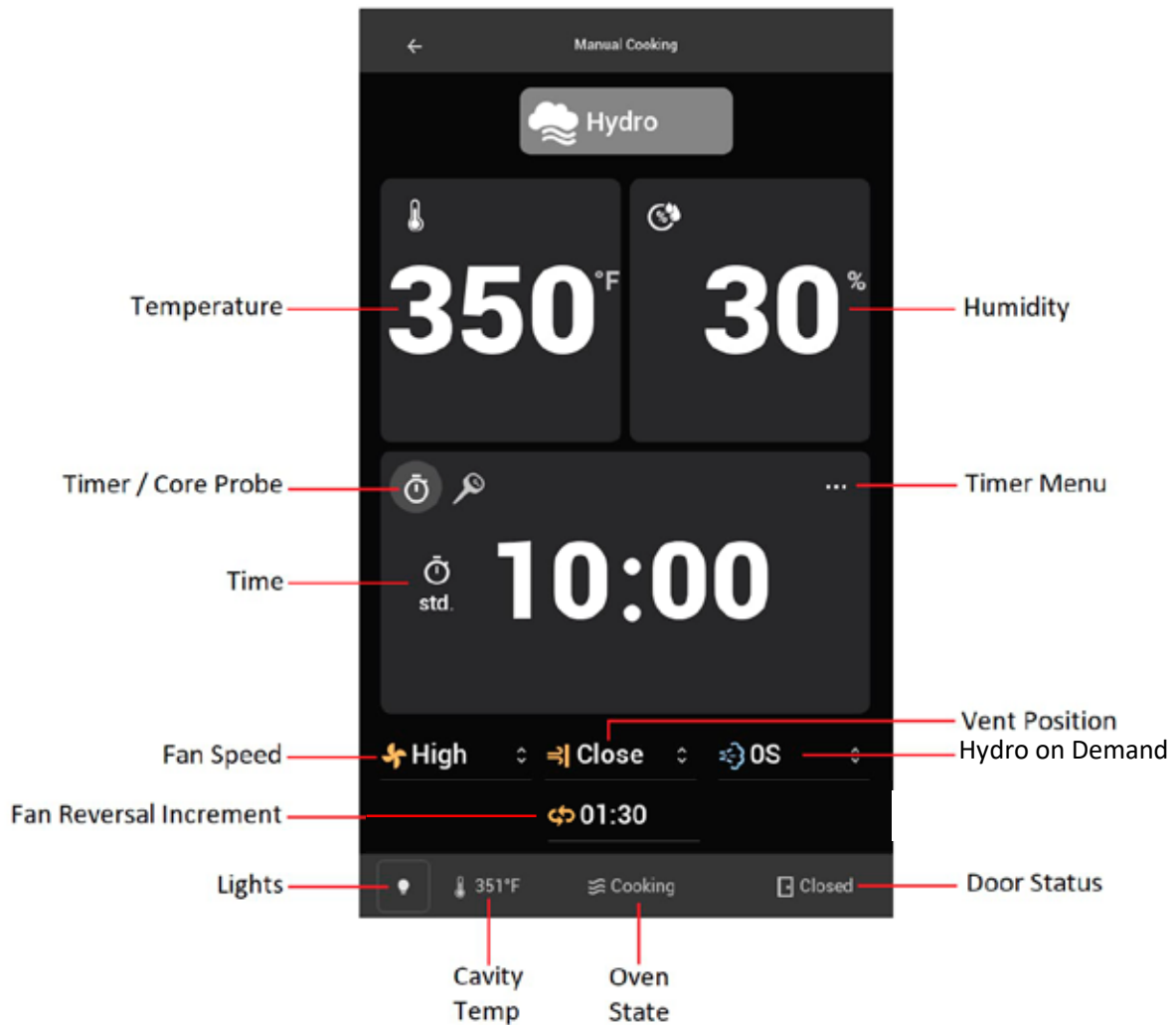
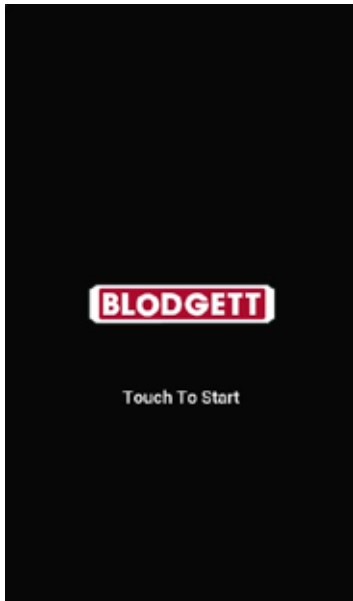

One Touch Touchscreen Control

Recipe Cooking

Create New Recipe

1. From the home screen, select RECIPE COOKING.



2. Press Create Recipe.

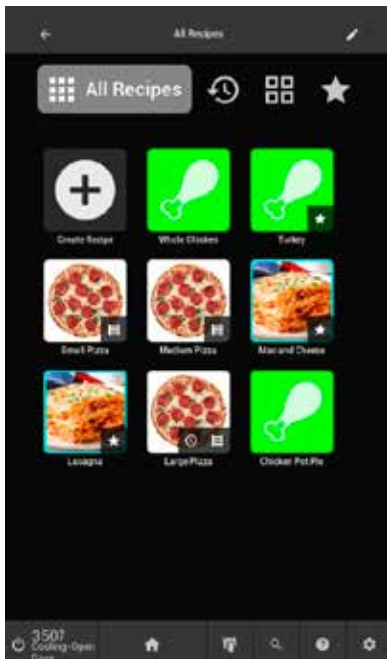

3. Use the  key and select recipe details.

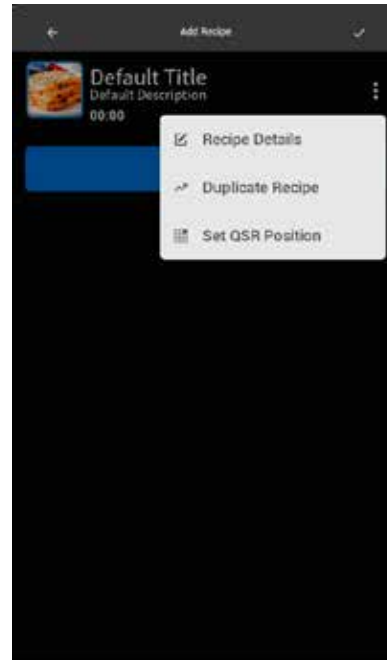

4. Touch each detail to edit. Using the presented keyboard, enter a recipe title and a short description. Use the → key to save.





Operation

One Touch Touchscreen Control

5. Touch **Select Image** to assign a new image to the recipe. Both general icons and custom images can be used.



6. OPTIONAL: From **Recipe Details**, touch **Set Group** to add the new recipe to one or more existing groups or create a new group. (See Creating Groups)



7. OPTIONAL: Selecting **Change Color** will present a palate to change the recipe icon color/border.

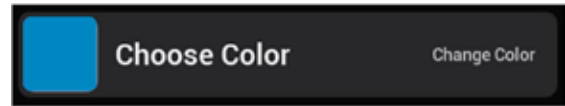

8. OPTIONAL: Select **Favorite** to mark the recipe as a favorite. The star will illuminate, and the recipe will be available from the favorites menu.



9. Once all desired fields have been completed touch the key to save the recipe details.

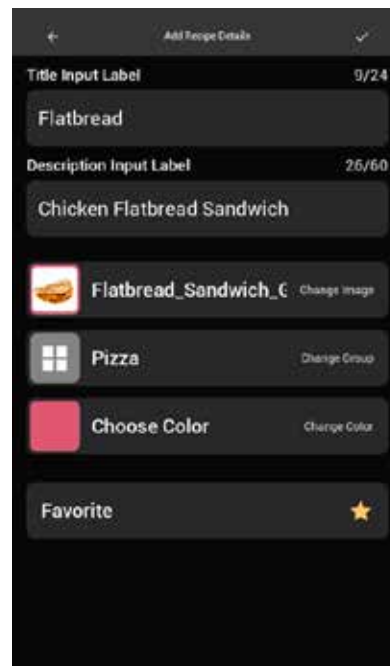

One Touch Touchscreen Control

10. Select **Add Step** to display the list of available cooking modes.

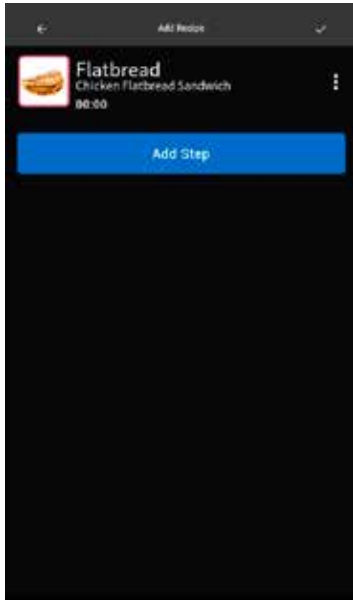

12. Enter the parameters of the selected cook mode similarly to a manual cook. Touch the key to save the step.



11. Select the first cooking step of the recipe.

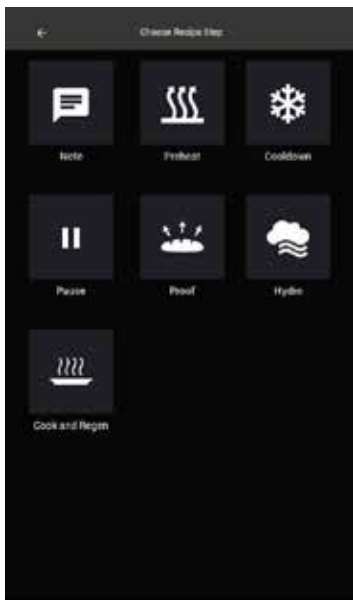

 **Fan Delay** - Recipe cooking can delay the rotation of the blower wheel in the cooking cavity. Touch the fan delay icon and use the provided keypad to enter a fan delay increment. Press → to save.

13. Repeat steps 10-12 until the recipe is complete. Use the key to create the recipe. Use the up and down arrows on each step to change the order the steps are executed.

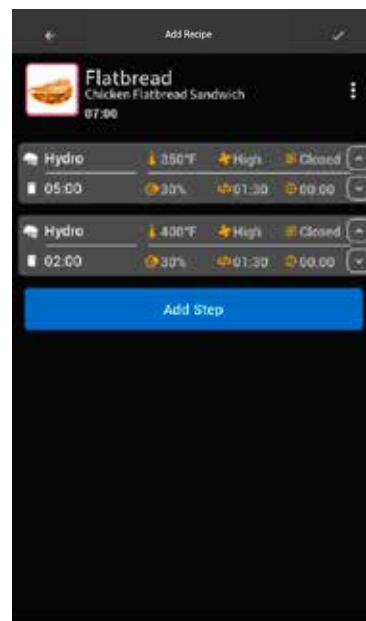

TIP: Start your recipe with a Preheat, followed by a Note to Load the product.



Operation

One Touch Touchscreen Control

Edit Existing Recipe

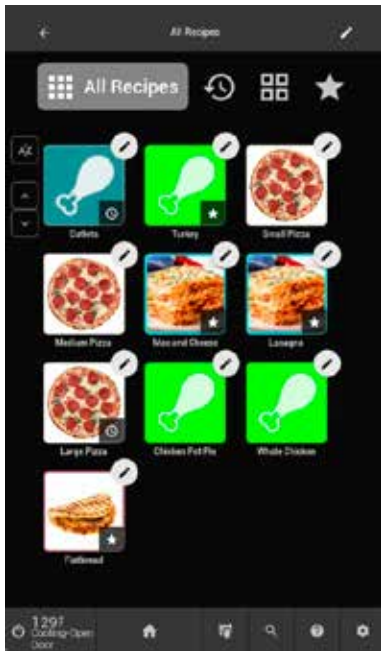

1. From the recipe selection screen touch the  key to enter edit recipe mode. Touch the pencil icon on any recipe to open the recipe edit menu.



2. From the recipe edit menu, recipes can be: added to a group, selected as a favorite, or deleted. Select **Recipe Details** to open the recipe edit screen.



3. The edit recipe screen operates just like the add recipe screen.

- Use the  key to edit recipe details.
- Touch **add step** to create a new cooking step for the recipe.
- Touch any existing step to edit it.
- Use the up/down arrows to the right of each step to change the order the steps are executed in.
- Touch the  key in the top right corner to confirm changes, or use the back arrow to discard changes.

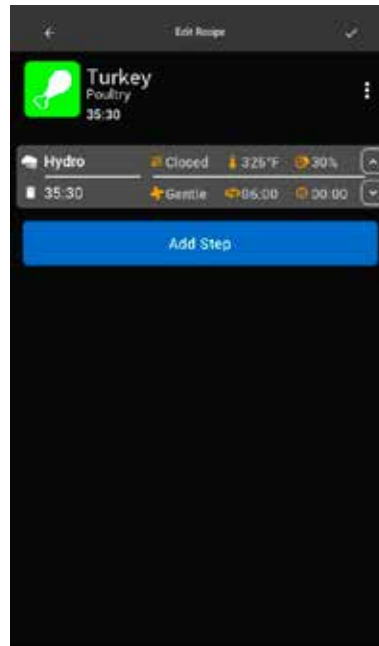

One Touch Touchscreen Control

Create New Group

1. From the home screen, select recipe cooking.
3. Select Create Group.

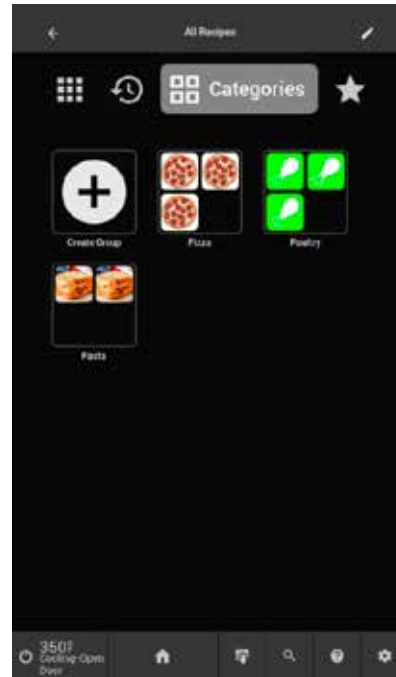

2. Select the Categories icon at the top of the screen.

4. Enter the desired group name. Touch the blue arrow to save and continue.

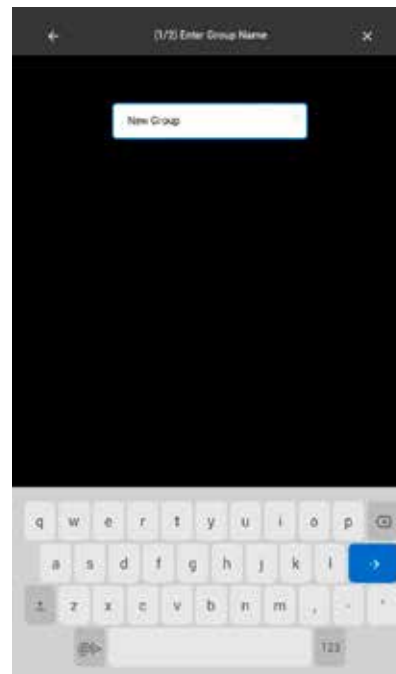
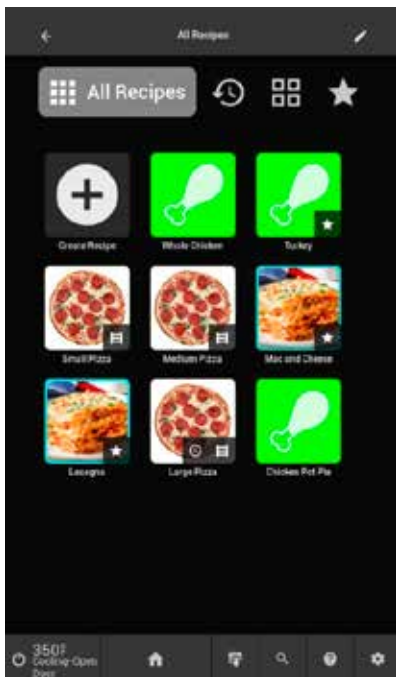



Operation

One Touch Touchscreen Control

5. Select the recipes to be featured in the newly created group. Then select **OK** to create the group.



2. Select **Edit Group Name** to change the name for the group. Select **Edit Group Contents** to add or delete recipes held in the group.



Edit Existing Group

1. From the group selection screen select the  key to enter edit group mode. Touch the pencil icon on any group to open the group edit menu.

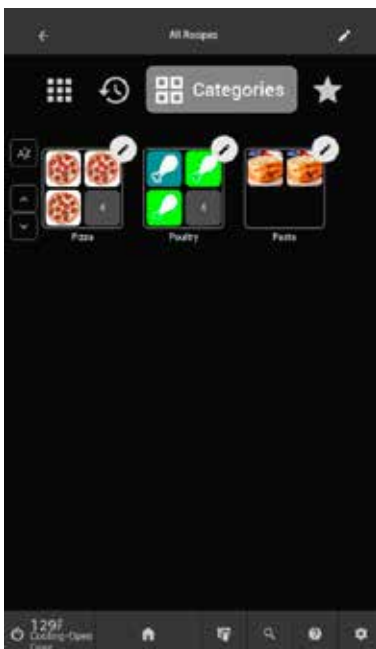

One Touch Touchscreen Control

Recipe Cooking

1. From the home screen, select **Recipe Cooking**.



2. From the recipe cooking screen, use the toolbar at the top of the screen to navigate between: All Recipes, Recent Recipes, Categories, and Favorites.

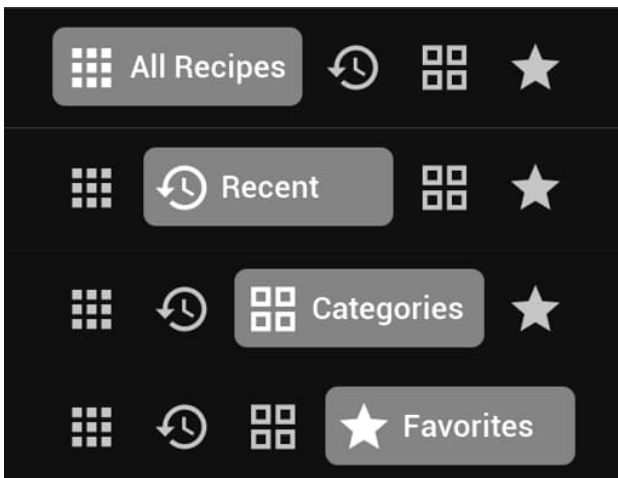

3. Swipe up and down to scroll through the existing recipes. Touch a recipe to select it for cooking.

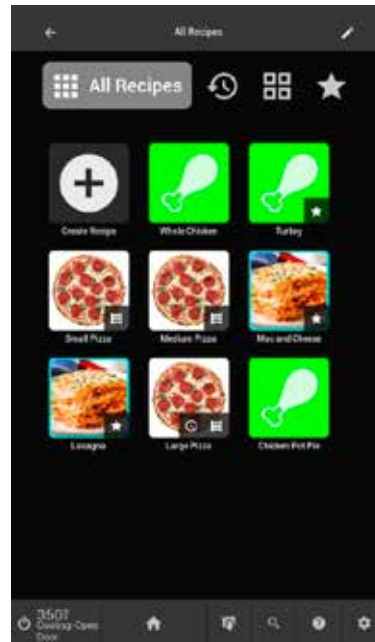

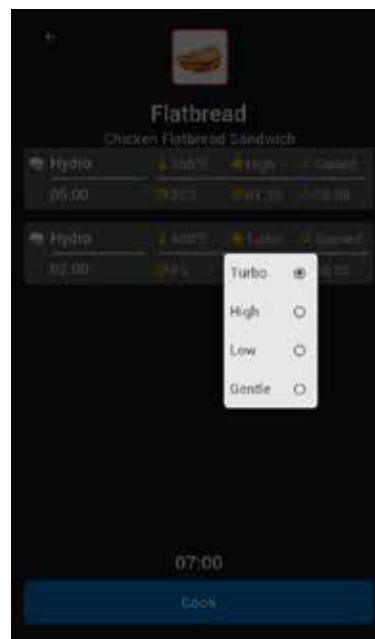

4. From the selected recipe screen, each parameter of the existing steps can be edited individually by touching them. Select **Cook** to begin the recipe cook.





Operation

One Touch Touchscreen Control

- At any time during the cook:
 - Touch +1min. or -1min. to add or subtract a minute from the remaining step timer.
 - Touch the  icon for hydro burst.
 - Touch  to toggle the cavity lights.



- When the cook time has expired, the display will flash **Recipe Complete**, the alarm will sound, and a timer will start to show the elapsed time since the recipe has completed.
 - Select **Finish** to return to the recipe selection screen.
 - Select +1min to add 1 minute to the previous step.

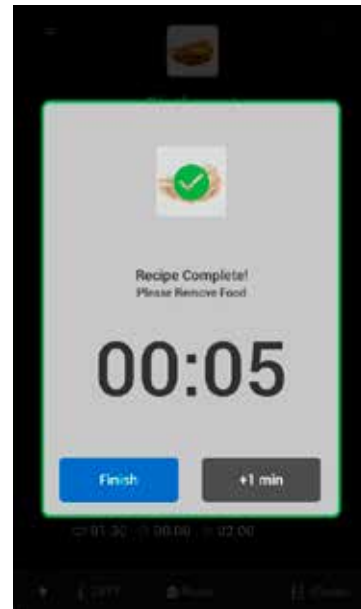

- Touch the  icon in the top left corner of the screen to view the current recipe steps. Select any parameter on a **future** step to adjust the recipe in real time. Touch the cook type icon to skip to that step.

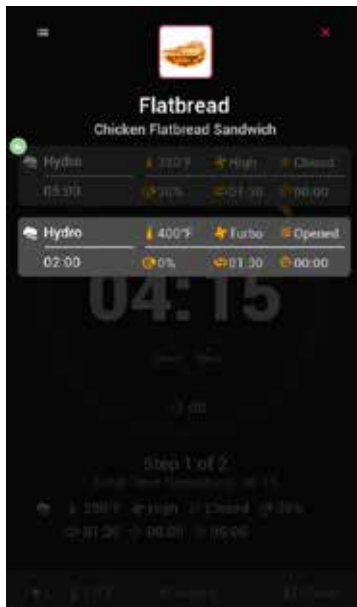



One Touch Touchscreen Control

Creating A Rack Timing Group

1. From the home screen, select **Rack Timing**. The Menu Planner screen will be displayed. Select **Create Group**.



2. Touch the  key to open the group creation menu. Touch **menu details**. Enter a title and description for the group. Touch  to save.



3. Touch **Add Recipes** to display the recipe selection screen. The first recipe selected will dictate the parameters for the entire group. Touch the  key to save and return to the **Create Menu** screen. *NOTE: Only recipes with the same cook mode, set temp, and humidity parameters can be added to the same group.*

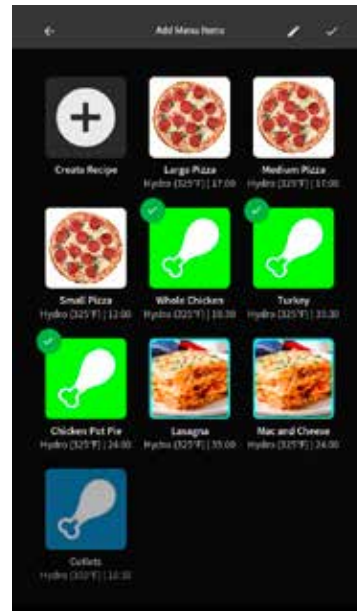

4. From the **Create Menu** screen, select the  key to save the rack timing group.

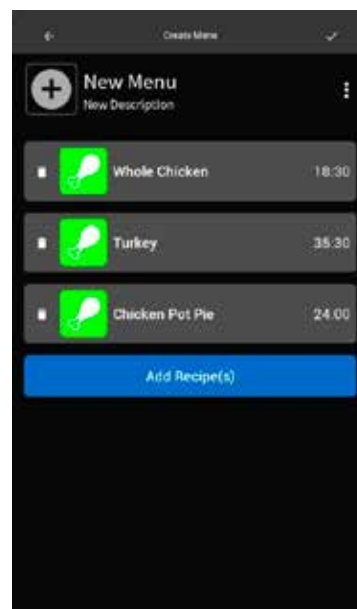



Operation

One Touch Touchscreen Control

Editing A Rack Timing Group

- From the rack timing menu planner, touch the pencil icon in the top right corner of the screen. The group edit icons will appear on each group.



Cooking with Rack Timing

- From the **Home Screen** select **Rack Timing**. The group selection screen will be displayed. Select a group, the menu summary screen will be displayed.



- To edit a group, touch the pencil icon on the group icon, then select **Edit Menu** in the presented window.



- Select **Cook** to open the rack timer and begin cooking.



- Once the group has been edited, select the  key to save the rack timing group.

One Touch Touchscreen Control

- The oven will begin preheating to the group's defined set temperature. The status indicator at the bottom of the screen will alert the user when the oven is ready, and the alarm will sound.

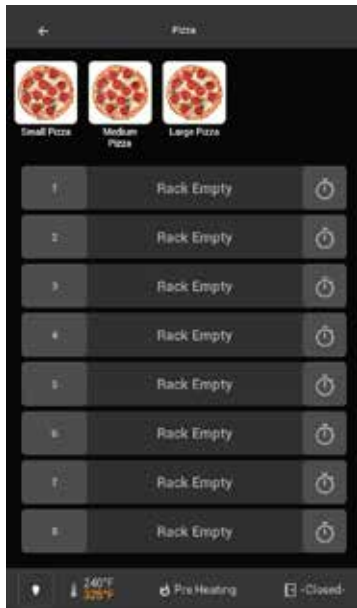

- Select the desired recipe at the top of the rack timing screen and select an open rack to set the timer. Recipes can also be selected and dragged to the desired position.

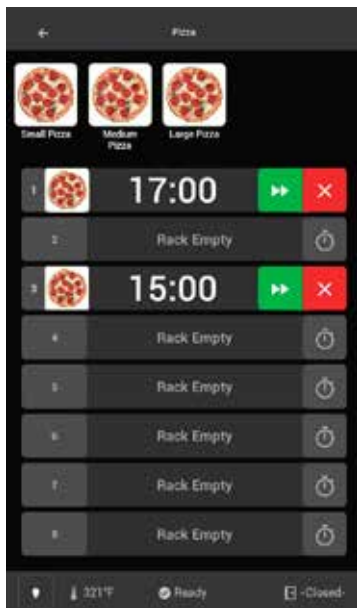

- Start timers by using the green arrow keys OR the timers will automatically start when the door is opened, then closed (product is loaded).

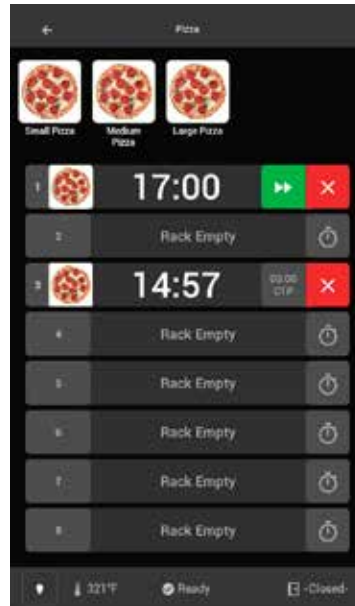

NOTE: Start key will not be displayed until the oven has reached the group set temperature.

- When a timer expires, the alarm will sound, and the corresponding rack will flash **DONE**. Touch the yellow unload product button to reset the timer. Use the +1min. key to add 1 minute to the timer.

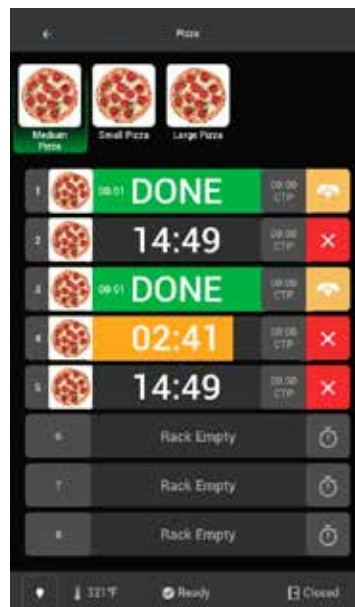



Operation

One Touch Touchscreen Control

7. To cancel a cook, press the  key next to the timer. To exit rack timing, touch the back arrow in the top left corner. A window will appear to ensure exiting was intentional. Select **Exit** to confirm.

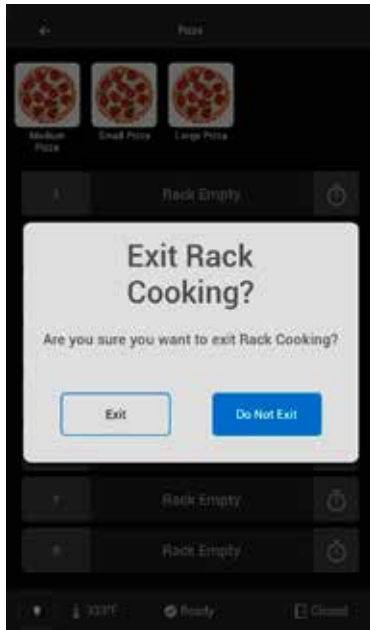

Cooling the Oven

1. To cool the oven, exit the current cooking mode using the back arrow in the top left corner. On the **Home Screen**, the oven will activate cool down mode. During **Cool Down** the vent will open and the main fan will run on high until the cavity reaches a safe temperature; 105°F. The main fan will continue to run with the door open for faster cooling.

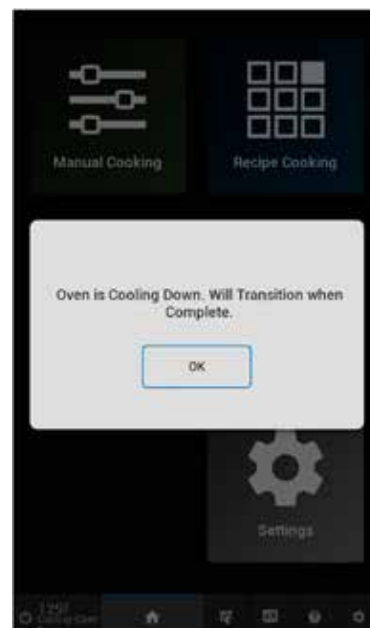

One Touch Touchscreen Control

Cleaning

1. Touch the screen wipe quick-key to wipe the control without causing inadvertent inputs. A 5 second count down will appear on the screen.

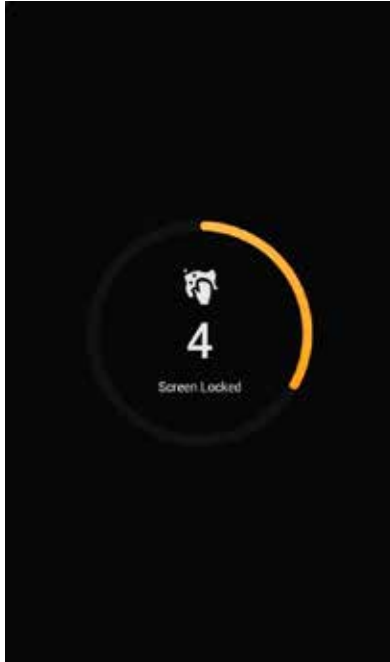

2. Select the Cleaning icon from the Home screen.
3. The Hydrovection has a Wash Cycle function that prepares the oven for manual cleaning. Select the wash cycle and the oven will run at high steam and low temperature.

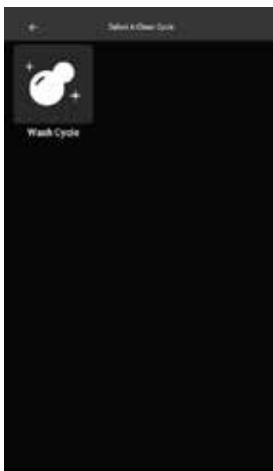

See other relevant cleaning information in the Maintenance section of this user manual.

USB Interface

1. Access the USB Export screen by touching the  button at the top left of the General Settings screen and then selecting "Menu."

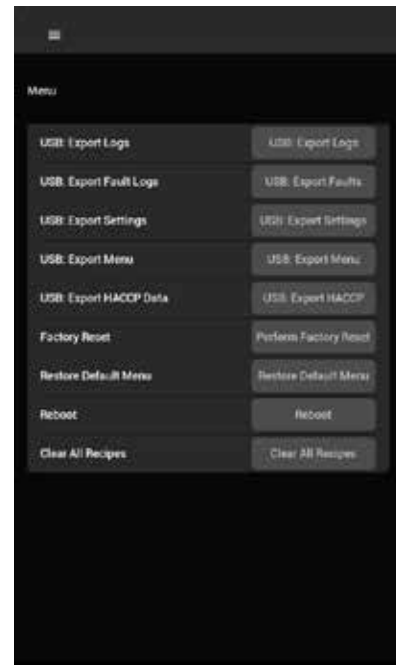

2. Touch the desired option and input a name for the file to export to the USB. Press the enter button and the export will be verified by a pop-up on the screen.

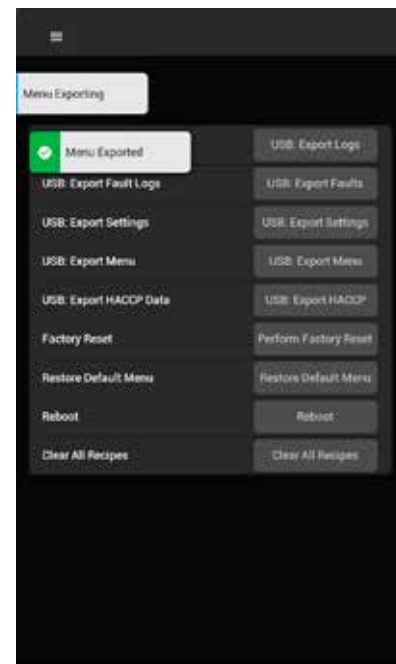



Operation

One Touch Touchscreen Control

3. To import from a USB, first navigate to the General Settings screen and toggle the field “Firmware Update” to show green. This setting activates the USB pop-up feature for when a USB is inserted into the USB port. The setting is off by default.
4. With the aforementioned setting turned on, insert a USB containing the menu, settings, and/or software you are looking to install on the oven.
5. Touch the circle next to the appropriate file and a dot will appear in the circle indicating selection. Touch the “Next” button to continue.

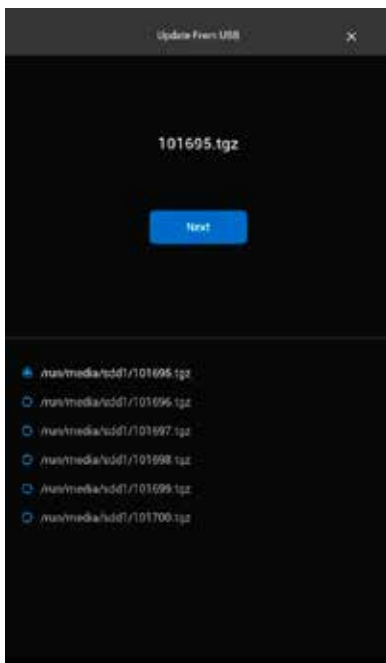

6. Touch the box to Select All, or select individually and then press Update.



7. The control will install the menu or the settings and indicate a successful upload. Or, in the case of a Software Update, the control will display a progress screen before indicating a successful upload.

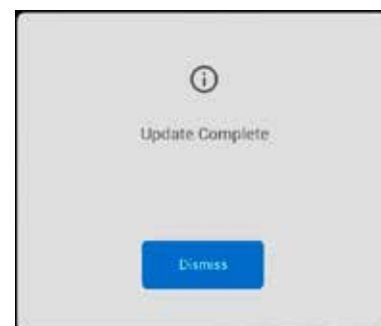
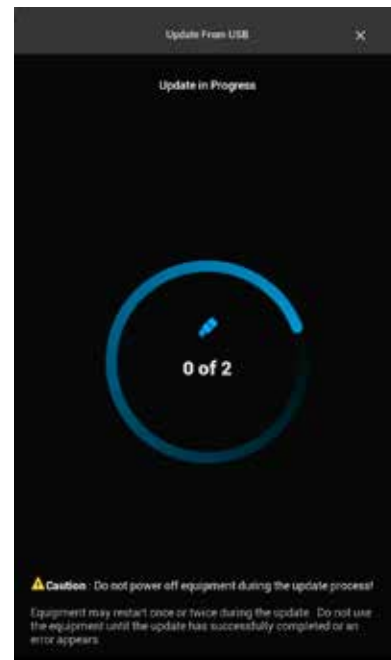



Spray Bottle Operating Procedure

NOTE: Only use a commercial oven cleaner/degreaser with the spray bottle. DO NOT use chemicals that are not intended as oven cleaners. See chemical manufacturer's information for intended use.

1. Unscrew the sprayer head and fill the container to the MAX mark. Screw the head assembly on firmly to ensure an airtight seal. The liquid must be clean and free from foreign matter. Do not overfill - space must be left for compressing air.
2. To build up pressure, pump approximately 20 full strokes when the container is filled with liquid. The higher the pressure, the finer the spray. If the container is only partially filled, then more pumping is required to compress the additional air space.
3. To spray, depress the trigger with your thumb.
4. Adjust spray nozzle for a wide spray pattern.
5. After a period of spraying, the pressure will drop. Restore the pressure by operating the air pump.
6. Release pressure after use by inverting the spray head and depressing the trigger or by slowly unscrewing the spray head assembly which will allow air to escape from around the filling aperture.
7. After use, rinse the spray bottle with clean water and check that the hole in the nozzle is perfectly clean and clear. Warm water (not hot) used with a household detergent is a useful cleaning agent for this purpose.

NOTE: Further information can be found in the instruction leaflet supplied with your spray bottle.



WARNING!!

Protective clothing and eyewear should be worn while using cleaning agents.

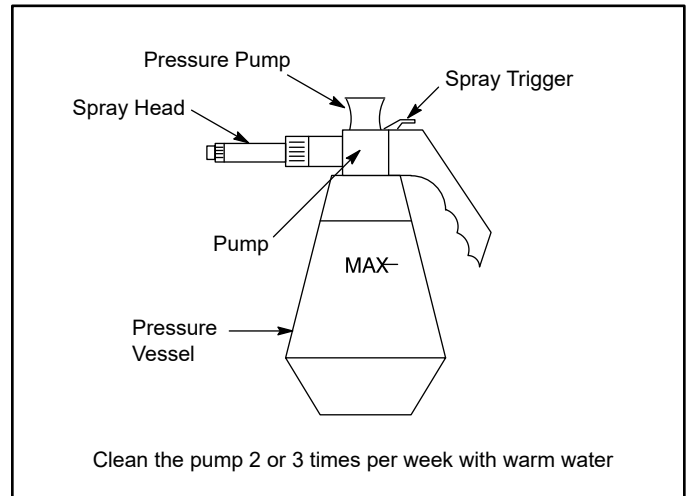

Figure 43

Complete Spray Bottle - P/N R0006

Spray Head Repair Kit - P/N R6332



Maintenance

Cleaning and Preventive Maintenance

DAILY CLEANING

Cleaning the Exterior

The exterior of the appliance may be cleaned and kept in good condition with a light oil. Saturate a cloth and wipe the appliance when it is cold; wipe dry with a clean cloth.



WARNING!!

DO NOT spray the outside of the appliance with water or clean with a water jet. Cleaning with a water jet can impregnate chlorides into the stainless steel, causing the onset of corrosion.

Cleaning the Interior

Daily cleaning of the appliance is essential for sanitation, and to ensure against operational difficulties. The stainless steel cavity may corrode with improper cleaning of the oven. Use an oven cleaning detergent in conjunction with the supplied spray bottle.

For difficult cleaning, allow the spray-on oven cleaner to work longer before rinsing.

1. Cool the appliance down to 140°F (60°C) or, if the oven has been idle, turn the Hydro mode on for 3 to 4 minutes in order to warm the cavity surfaces.
2. Fill the spray bottle and pump air into the container with the pressure pump.
3. Spray the interior of the oven with a cleaning solution. Be certain to spray cleaner through the fan guard to cover all surfaces.

NOTE: Never spray water into the appliance when the temperature is above 212°F (100°C).

4. Let the cleaner work the time recommended by the cleaning solution manufacturer. For difficult, baked on grease, etc. allow to work over night.
5. Set the timer for 15 to 20 minutes.
6. Run the oven at 225°F (107°C) in the Hydro mode with 100% humidity. This will soften all burned on residue.
7. Rinse the appliance interior with water (a hose is supplied, but take care that only the interior cavity is sprayed with water). Wipe the interior dry after rinsing.
8. The door should be kept slightly open after cleaning. This will allow the oven to vent and increase the life of the door gasket.

On stainless interiors, deposits of baked on splatter, oil, grease or light discoloration may be removed with a good non toxic industrial stainless steel cleaner. Apply cleaners when the oven is cold and always rub with the grain of the metal. The racks, rack supports and the blower wheel may be cleaned in the oven or by removing them from the oven and soaking them in a solution of ammonia and water.

NOTE: DO NOT use corrosive cleaners not intended for oven cleaning on your Hydrovection oven.

Recommended cleaners:

- ECOLAB Greasecutter Plus
- CELLO EZ Clean
- Diversey-Lever Advance Oven Cleaner



WARNING!!

Be sure to read and follow the MSDS or safety instructions on the bottle for your oven cleaner.



Cleaning and Preventive Maintenance

WEEKLY CLEANING

In addition to the daily cleaning it is necessary to clean the air intakes on a weekly basis. Air intakes provide necessary cooling air to the internal components. They are generally located on the rear and sides of the equipment.

It is also important to clean the control filter and behind the fan guard on a weekly basis. This is necessary for proper functioning of the oven. Scale will build up on the fan and heat source leading to a less efficient oven.

1. Turn off the oven. Make sure that the oven is cooled down to under 140°F (60°C).
2. Remove the rack guides.

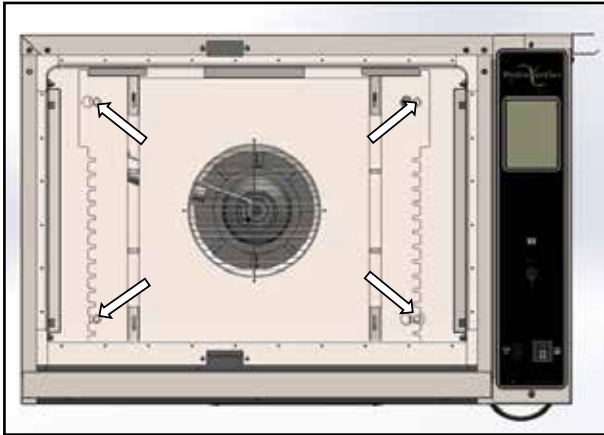

Figure 44

3. Four screws secure the baffle to the baffle side supports in the rear of the oven liner.
4. Using a 3/8" hex head wrench, loosen the four screws by three turns, but do not remove the four screws. The baffle is mounted with a key-hole design, so the hardware does not have to be fully removed to remove the baffle.
5. Slide the baffle to the right so that the heads of the screws line up with the large cut out of the keyhole.

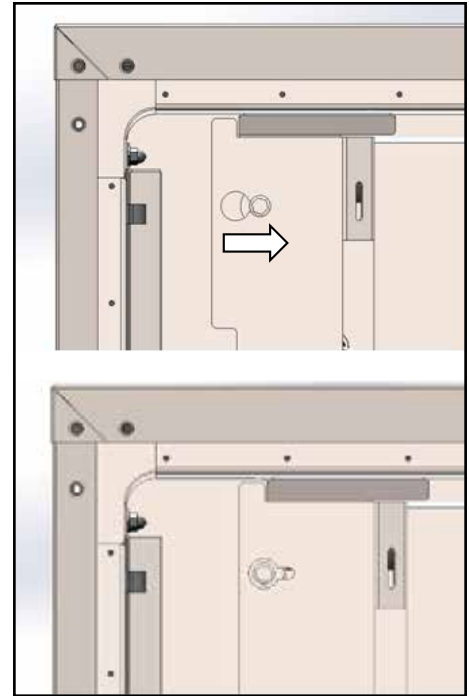

Figure 45

6. Pull the baffle towards the front of the oven to remove.
7. Thoroughly spray cleaner onto the fan and heat source. Close the door and allow the cleaner to work.
8. After ten minutes, rinse the cleaner off.
9. Reinstall the baffle by reversing the removal steps. Don't forget to tighten all four baffle mounting screws.

Note: It is recommended to remove and thoroughly clean the blower wheel every six months.

PREVENTIVE MAINTENANCE

The best preventive maintenance measures are the proper initial installation of the equipment and a program for cleaning the appliance routinely. The Hydrovection requires no lubrication. Contact the factory, the factory representative or a local Blodgett service company to perform maintenance and repairs should they be required.