



Model GSP30B



Model #: _____

Serial #: _____



**Instruction Manual for Globe
Label Printing Scale Model GSP30B**

For all after sales support, visit www.globefoodequip.com

- Complete the Warranty Registration
- Find an Authorized Servicer
- View Parts Catalogs

For additional Technical Support call Globe at 1-866-260-0522.

For additional GSP30B documentation visit
<https://globefoodequip.com/products/scales/label-printing/gsp30b.html>.

- IMPORTANT SAFETY NOTICE -

This manual contains important safety instructions that must be strictly followed when using this equipment.

Maintain and use this manual as a reference for training.

Index

IMPORTANT NOTICE	3
SAFETY TIPS	3
INSTALLATION	4
KEY SCALE COMPONENTS	4
LOADING/UNLOADING LABELS	5-6
INITIAL SCALE SET UP	
Changing Current Date And Time	6
Entering Shop Name And Address	7
PLU (Price Look Up) SET UP	
Setting Up Weighted Items PLUs	8-10
Editing PLU Details	10
Editing PLU Dates	11
Editing PLU Barcode	12
Editing Unit Price Dates	12
Setting Up Default PLU	13
Default PLU Activation/Deactivation	13
Operating the Default PLU	13
Deleting A PLU	13
PRESET KEY SET UP	
Setting Up Preset Keys	14
Setting Up Cassette Preset Keys	14
Setting Up Tare Preset Function Keys	15
Setting Up Preset Function Keys	16
Deleting Preset Keys	16
SAMPLES of All Available Labels for the GSP30B	17
OPERATING INSTRUCTIONS (PLU'S)	
Manual Label Print	18
Automatic Label Print (Weighed Items)	18
Automatic Label Print (Fixed Priced Items)	18
Using Function Keys	19-22
CLEANING/MAINTENANCE	23
TROUBLESHOOTING	24
TARE WEIGHT	25
USB SCALE BACKUP AND RESTORE	
Scale To USB	26
USB To Scale	26-27
ADDITIONAL FEATURES	27



GLOBE FOOD EQUIPMENT CO.
2153 DRYDEN RD
DAYTON, OH 45439
TOLL FREE: 800-347-5423
PHONE: 937-299-5493
FAX: 937-299-4147
E-MAIL: info@globefoodequip.com
WEBSITE: www.globefoodequip.com

Important Notice

YOU MUST CALL YOUR LOCAL WEIGHTS AND MEASURES OFFICE BEFORE YOU USE YOUR NEW SCALE. USUALLY WEIGHTS AND MEASURES IS A DEPARTMENT OF THE COUNTY AUDITOR'S OFFICE. THIS SCALE MUST BE CERTIFIED BEFORE IT CAN BE USED.

YOU RUN THE RISK OF BEING FINED IF THIS SCALE IS NOT CERTIFIED BY YOUR LOCAL WEIGHTS AND MEASURES.

<https://www.nist.gov/pml/owm/resources-weights-and-measures/state-weights-and-measures-directors>

Safety Tips

This manual contains a number of precautions to follow in order to help promote safe use of this equipment.

Warnings affecting your personal safety are indicated by:



Warnings related to possible damage to the equipment are indicated by:



To ensure safe operation, the general safety tips below must be followed.

- **DISCONNECT** the scale from the power source (unplug) before servicing or opening
- **ONLY** trained and qualified service personnel should attempt repairs
- **ONLY** use correct type and rating of fuses and parts
- **NEVER** immerse the scale in water or spray with hose
- **DO NOT** put the scale in a dishwasher

GROUNDING

This machine is provided with a three prong grounding plug. The outlet to which this plug is connected must be properly grounded. If the receptacle is not the proper grounding type, contact an electrician. Do not, under any circumstances, cut or remove the third (ground prong) from the power cord or use any adapter plug (Figure 3-1 and Figure 3-2).



Figure 3-1 Correct



Figure 3-2 Incorrect

Installation

Inspect the package carefully before unpacking. Note any damage on the delivery paperwork and take pictures.

Unpack the scale immediately after receipt. If the machine is found to be damaged, immediately contact us at help@globefoodequip.com or call 1-800-347-5423 ext. 253. Please include your name, serial #, item that is damaged, explanation of the damage and photographs if possible. The damage must be reported to Globe within 7 days from the time of shipment. Refer to Globe's Freight Damage policy for more information.

[https:// globefoodequip.com/support/order-return-policy.html](https://globefoodequip.com/support/order-return-policy.html)

Make sure the scale is placed on a stable, flat surface.

Avoid the following areas when installing the machine:

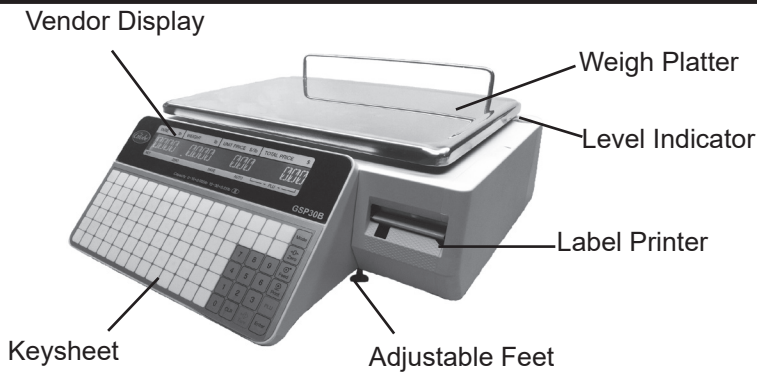
- Areas subject to high temperatures or high humidity
- Areas exposed to direct sunlight
- Areas where water or other liquids can be easily spilled on the machine
- Areas subject to excessive vibration or unstable surfaces
- Areas exposed to direct cold air
- Areas subject to low temperatures
- Areas subject to a lot of dirt
- Areas with large voltage fluctuations

Check the level indicator to make sure the scale is level. If the machine is not level, weighing may not be accurate.

To adjust the machine to a level position, rotate the four adjustment feet until the level bubble is completely centered in the round level indicator.

Plug the power cord into the AC power outlet on the bottom side of the scale.

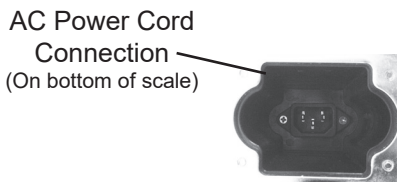
Key Scale Components



Operating Keysheet

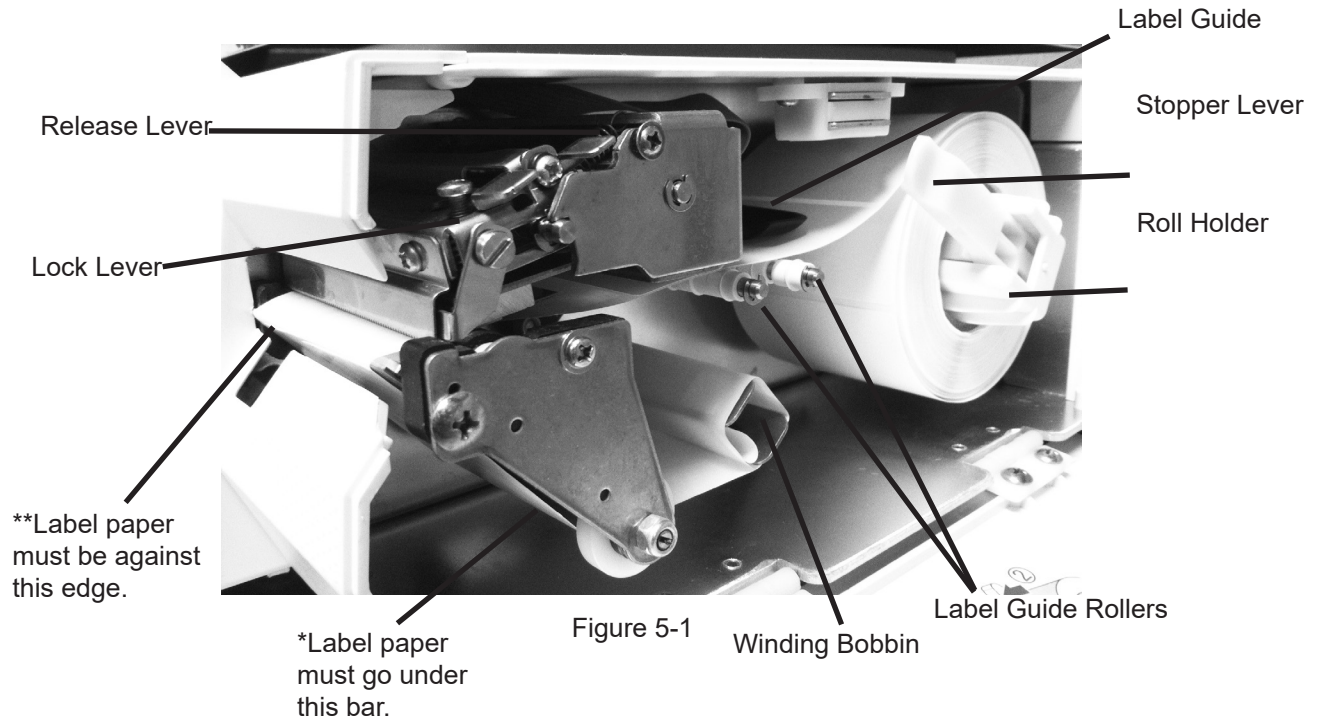


Scale Set-Up Keysheet



(Ethernet Cable required to connect with PC)

Loading/Unloading Labels



Only use Globe Food Equipment Labels. Damage to thermal head can occur. To order labels, contact a local Globe Representative or Globe Food Equipment.

IMPORTANT: Before installing a new roll of labels, remove 5 to 6 blank labels so only backing paper is fed through the printer.

Loading Roll of Labels

1. Open the side cover.
2. Release the printer head by pushing the release lever down. See Figure 5-1.
3. Make sure the stopper lever of the roll holder is pulled down.
4. Load the label roll onto the roll holder.
5. Insert the label paper (with the label side up) under the label guide and over the two label guide rollers. See Figure 5-1.
6. Continue to pull the label paper through and make sure it is fed over the metal bar shown in Figure 5-2 and under the bar*. See Figure 5-1.
7. Turn the winding bobbin counter clockwise so the slot is on the top. See Figure 5-3.
8. Insert the paper under the slot on the winding bobbin. See Figure 5-3.
9. Pull up on the stopper lever, then slide it inwards to secure the label roll.
10. Make sure the label paper is against the edge**. See Figure 5-1.
11. Push down on the lock lever until the print head locks into position.
12. With the scale plugged in and turned on, press the Feed key on the keypad once or twice in order to securely turn the paper around the winding bobbin. Continue to press the Feed button until the labels are ejected from the printer.

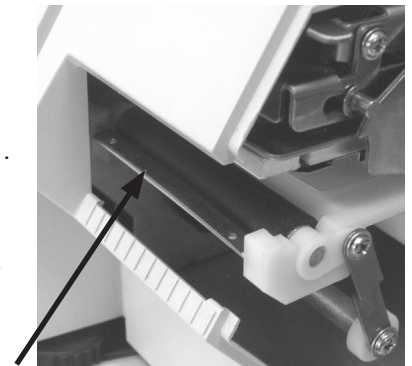


Figure 5-2



Figure 5-3

NOTE: If you receive an error message (1011), it indicates that the label is not in the proper position. Press the CLR key then press the Feed key again to feed the labels through the printer. You may need to do this step a couple of times.

13. Close the side cover.

Loading/Unloading Labels

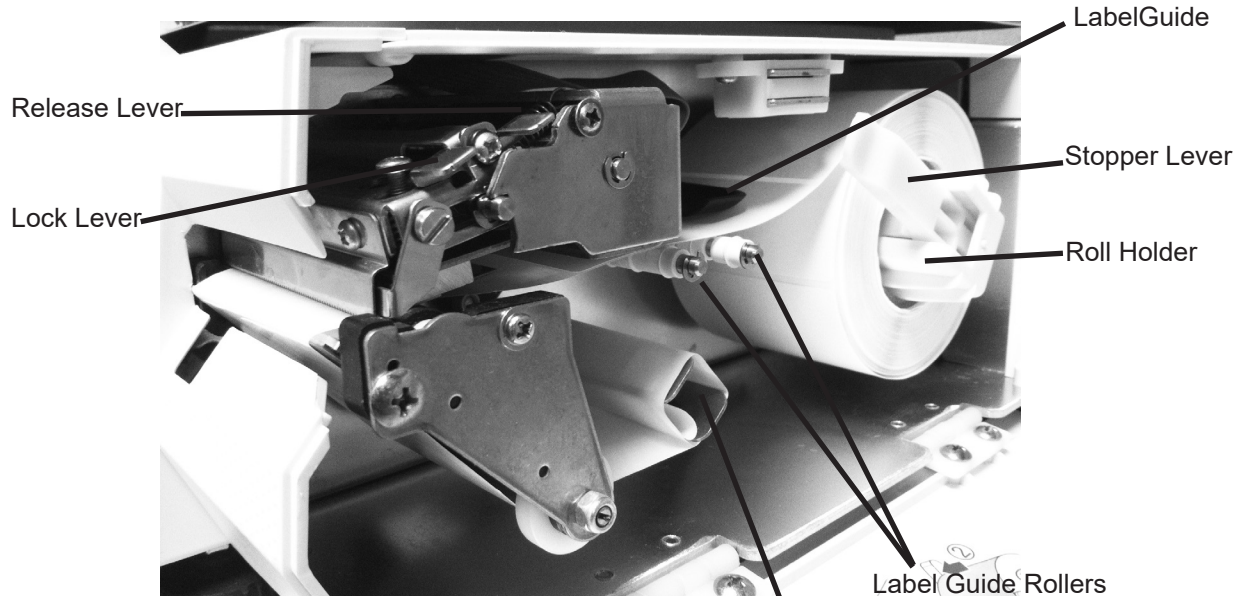


Figure 6-1 Winding Bobbin

Unloading Remaining Label Roll

1. Open the side cover.
2. Release the printer head by pushing down on the release lever. See Figure 6-1.
3. Pull the winding bobbin lever outwards to loosen the paper wound around the winding bobbin; then remove the paper from the winding bobbin.
4. Pull the stopper lever of the roll holder to make it straight; then remove the label roll from the path and the roll holder.

Initial Scale Set Up

Changing Current Date And Time

IMPORTANT: Before using the scale for the first time, follow these steps to make sure that the current date and time is displayed.

1. Make sure the scale is plugged in, turned on and there is nothing on the weigh platter.

NOTE: The “Clock Check” screen will display. See Figure 6-2.

2. Press the Enter key on the keypad to proceed.
3. Key in 4000 and press the Mode key. The display will show: C00 ADJUST
4. Press the Enter key. Display will show : C01 DATE TIME
5. Key in 111111 and press the PLU key.
6. Press the Enter key. Display will show: C01-01 DATE and date displayed
7. Key in new date data.

Example: April 1, 2015
Key in 04012015

8. Press the Enter key. The date will be displayed as month, day and year. If date is correct, press the Enter key. If not correct, key in the new date and press the Enter key. Display will show: C01-02 TIME and time displayed



Figure 6-2

Initial Scale Set Up

- The time will be displayed as military time with time separators between the hour, minute and seconds. If the time is correct, press the Enter key. If not correct, key in the new time (hour, minute, seconds) and press the Enter key.
- After the date and time have been entered, press the Mode key. Display will show 19001-000 ENT or CLR
- Press the Mode key three times to return to normal operation.

NOTE: To make sure that the date and time is correct, power off the scale and then power on the scale to view the “Clock Check” screen.

Entering Shop Name And Address (optional)

- Make sure the scale is plugged in, turned on, and there is nothing on the weigh platter.
- Key in 9000 and press the Mode key. The display will show: P00 PROGRAM
- Key in 5 and press the ENTER key. Display will show: P06 STORE
- Key in 111111 and press the PLU key. Display will show: P06 STORE
- Press the Enter key. Display will show: P06-00 NO. 0001 >No<
- Press the Enter key. Display will show P06-01 NAME >ED
- Press the Edit key. Display will show 13001-0000 ENT or CLR.
- Press the Enter key. Display will show INP 0001-0000-00
See Figure 7-1.
- Use the Scale Set-Up keysheet to key in the store name (48 character maximum).

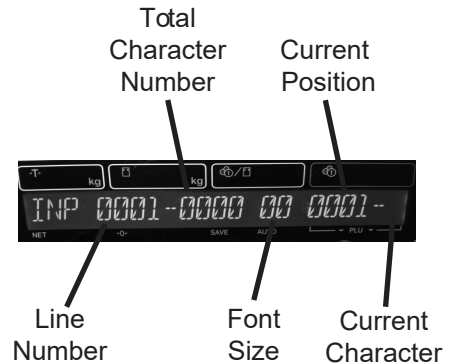


Figure 7-1

- Use the Scale Set-Up keysheet to key in the store name (48 character maximum).

NOTE: Only one character of the store name will display at a time. Use the right arrow key on the Scale Set-Up keysheet to cycle through the letters of the store name.

NOTE: To enter one of the symbols (not a letter), select the symbol key. If the symbol needed is on the top of the symbol key, select the shift key then the appropriate symbol key.

NOTE: To delete a character that is not needed, press the Back Space key or arrow keys and Char Delete key.
- After the store name has been entered, press the Mode key. Display will show 19001-0000 ENT or CLR
NOTE: Press Enter to save or CLR to cancel.
- Press the Enter key. Display will show: P06-00 NO. 0001 >No<
- Press the down arrow on the Scale Set-Up keysheet two times. Display will show: P06-02 ADDRESS >ED
- Press the Edit key. Display will show INP 0001-0000-00
- Use the Scale Set-Up keysheet to key in the store address (this includes the street address, city, state, and zip) (@48 character maximum).

NOTE: To enter one of the symbols (not a letter), select the symbol key. If the symbol needed is on the top of the symbol key, select the shift key then the appropriate symbol key.
- After the store name has been entered, press the Mode key. Display will show 19001-0000 ENT or CLR
NOTE: Press Enter to save or CLR to cancel.
- Press the Mode key three times to return to normal operation.

PLU (Price Look-up) Set Up

Setting Up Weighted Items PLUs

(Items whose total price depends on the weight of the item)

A PLU (Price Look-up) is a unique number assigned to a product and can be any number between 2 and 99999 (The number 1 is reserved for the default PLU. See Setting up Default PLU for more info on PLU #1).

1. Make sure the scale is plugged in, turned on and there is nothing on the platter.
2. Key in 9000 and press the Mode key. Display will show: P00 PROGRAM
3. Key in 111111 and press the PLU key. The display will not change.
4. Press the Enter key. Display will show: P01 PLU
5. Press the Enter key again. Display will show: P01-00 PLU >No<
6. Key in the PLU number (5 digit maximum) and press the PLU key. If this is a new PLU the display will show: 13001-0000 ENT OR CLR.

NOTE: Press the Enter key to accept the PLU number or the CLR key to cancel. CLR will return you to the PLU number entry screen and Enter will move forward to the top of the PLU entry menu.



Figure 8-1

7. Display will show: P01-01 <SALE1>
8. Press the Edit key. See Figure 8-1. Display will show: INP 0001-0000 00
9. Use the Scale Set-Up Keysheet to key in the PLU name (24 character maximum per line, 2 line maximum*, e.g. GROUND BEEF, BANANAS). See Figure 8-2.
10. Enter the first line of data. If you only want one line of data, then press the Enter key. If you want additional lines of data, press the New Line key. Enter the second line of data, and press the Enter key to complete. See Figure 8-3. Display will show: P01-01 <SALE1>
11. Press the Enter key. Display will show: P01-01-01 SALES 0
12. Verify the number on the right is 0 and press Enter. If the number is not 0, key in 0 and press Enter twice. Display will show: P01-01-04 PRICE 0.00.
13. Key in the unit price (5 digit maximum do NOT include decimal) and press the Enter key.
14. Press the Enter key again. Display will show: P01-01-10 TARE 0.000
15. Key in the tare weight (4 digit maximum/2 digit minimum - tare weight is a three place decimal that must end in 0 or 5) or 0 if none and press the Enter key two times. Display will show: P01-01-12 P TARE 0.0

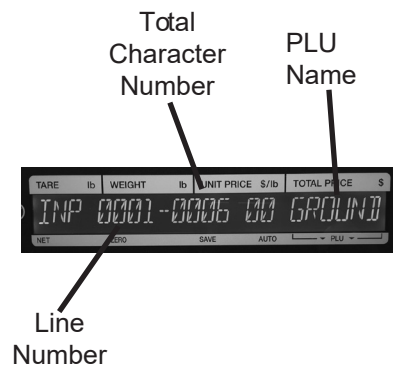


Figure 8-2

- NOTE: For a detailed explanation of tares, refer to the Tare Weight section.**
16. Key in the tare percentage (3 digit maximum) or 0 if none and press the Enter key.
 17. Press the Enter key again. Display will show: P01-01 <SALE1>
 18. To set which dates to print use the right arrow key on the Scale Set-Up Keysheet. Display will show: P01-06 <DATE>

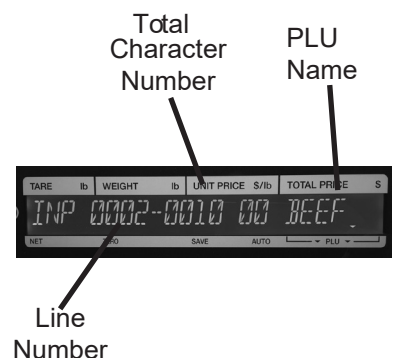


Figure 8-3

19. Press the Enter key. Display will show: P01-06-01 P/D PRN #
- NOTE: Select 1 for package date to appear on label or 2 to remove package date from label.**
20. Key in your selection and press the Enter key.
21. Press the Enter key again. Display will show P01-06-04 SB DATE PRN #
- NOTE: Select 1 for sell by date to appear on label or 2 to remove sell by date from label.**
22. Key in your selection and press the Enter key.

PLU (Price Look-up) Set Up

23. Press the Enter key again. If you chose to NOT display the shelf life skip to step 25. If you chose to display the shelf life the display will show: P01-06-07 SHELF LF 1
24. Key in the number of days to expire (3 digit maximum, 1-999 days) and press the Enter key twice.
25. Display will show: P01-06 <DATE>
26. Use the right arrow key on the Scale Set-Up Keysheet to select the code. Display will show P01-07 <CODE>
27. Press the Enter key. Display will show: P01-07-01 CODE 00000000

NOTE: The barcode can be the PLU number, which the scale defaults to, or the POS (point of sale) number. If the PLU number is to be in the barcode simply press the Enter key. If the POS number is to be in the barcode, key in the POS number (5 digit maximum) and press the Enter key. The scale can be reprogrammed to accept a 6 digit PLU or POS number. Contact Globe's Technical Service Department for assistance.

NOTE: To Preview the label press the Print button. The price will be blank.

28. Press the Mode key. Display will show: 19001-0000 ENT OR CLR.

NOTE: Press the Enter key to save or the CLR key to cancel.

29. Display will show P01-00 No. # >PL
 30. Repeat steps 6 through 28 of Setting Up Weighted PLUs or Setting Up Fixed Price PLUs to enter additional PLU numbers. When complete, press the Mode key three times to return to normal operation.
- * The E11 & E12 labels support 2 lines of data. The E13 ingredient labels will support up to 11 lines of data. For more options free software is available for PC <https://globefoodequip.com/products/scales/label-printing-scale/>

Setting Up Fixed Price Items PLUs

(Items whose total price DOES NOT depend on the weight of the item)

A PLU (Price Look-up) is a unique number assigned to a product and can be any number between 2 and 99999 (The number 1 is reserved for the default PLU. See Setting up Default PLU for more info on PLU #1).

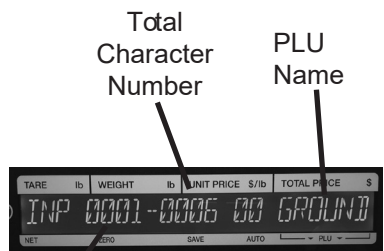
1. Make sure the scale is plugged in, turned on and there is nothing on the platter.
2. Key in 9000 and press the Mode key. Display will show: P00 PROGRAM
3. Key in 111111 and press the PLU key. The display will not change.
4. Press the Enter key. Display will show: P01 PLU
5. Press the Enter key again. Display will show: P01-00 PLU >No<
6. Key in the PLU number (5 digit maximum) and press the PLU key. If this is a new PLU the display will show: 13001-0000 ENT OR CLR.

NOTE: Press the Enter key to accept the PLU number or the CLR key to cancel. CLR will return you to the PLU number entry screen and Enter will move forward to the top of the PLU entry menu.

7. Display will show: P01-01 <SALE1>
8. Press the Edit key. See Figure 9-1. Display will show: INP 0001-0000 00
9. Use the Scale Set-Up Keysheet to key in the PLU name (24 character maximum per line, 2 line maximum*, e.g. GROUND BEEF, BANANAS). See Figure 9-2.
10. Enter the first line of data. If you only want one line of data, then press the Enter key. If you want additional lines of data, press the New Line key. Enter the second line of data, and press the Enter key to complete. See Figure 9-3. Display will show: P01-01 <SALE1>
11. Press the Enter key. Display will show: P01-01-01 SALES 0
12. Key in 1 and press the Enter key. Display will show P01-01-01 SALES 1

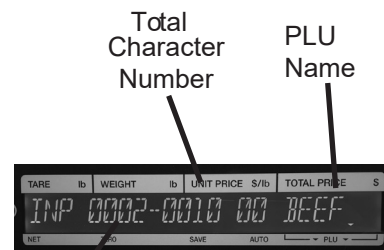


Figure 9-1



Line Number

Figure 9-2



Line Number

Figure 9-3

PLU (Price Look-up) Set Up

13. Press the Enter key again. Display will show: P01-01-04 PRICE 0.00.
 14. Key in the unit price (5 digit maximum do NOT include decimal) and press the Enter key.
 15. Press the Enter key again. Display will show: P01-01-06 QTY 0
 16. Key in quantity. Press the Enter key.
 17. Press the Enter key again. Display will show: P01-01 <SALE1>
 18. To set which dates to print use the right arrow key on the Scale Set-Up Keysheet. Display will show: P01-06 <DATE>
 19. Press the Enter key. Display will show: P01-06-01 P/D PRN #
NOTE: Select 1 for package date to appear on label or 2 to remove package date from label.
 20. Key in your selection and press the Enter key.
 21. Press the Enter key again. Display will show P01-06-04 SB DATE PRN #
NOTE: Select 1 for sell by date to appear on label or 2 to remove sell by date from label.
 22. Key in your selection and press the Enter key.
 23. Press the Enter key again. If you chose to NOT display the shelf life skip to step 25. If you chose to display the shelf life the display will show: P01-06-07 SHELF LF 1
 24. Key in the number of days to expire (3 digit maximum, 1-999 days) and press the Enter key twice.
 25. Display will show: P01-06 <DATE>
 26. Use the right arrow key on the Scale Set-Up Keysheet to select the code. Display will show P01-07 <CODE>
 27. Press the Enter key. Display will show: P01-07-01 CODE 00000000
NOTE: The barcode can be the PLU number, which the scale defaults to, or the POS (point of sale) number. If the PLU number is to be in the barcode simply press the Enter key. If the POS number is to be in the barcode, key in the POS number (5 digit maximum) and press the Enter key. The scale can be reprogrammed to accept a 6 digit PLU or POS number. Contact Globe's Technical Service Department for assistance.
NOTE: To Preview the label press the Print button.
 28. Press the Mode key. Display will show: 19001-0000 ENT OR CLR.
NOTE: Press the Enter key to save or the CLR key to cancel.
 29. Display will show P01-00 No. # >PL
 30. Repeat steps 6 through 28 of Setting Up Weighted PLUs or Setting Up Fixed Price PLUs to enter additional PLU numbers. When complete, press the Mode key three times to return to normal operation.
- * The E11 & E12 labels support 2 lines of data. The E13 ingredient labels will support up to 11 lines of data. For more options free software is available for PC <https://globefoodequip.com/products/scales/label-printing-scale/>

Editing PLU Details

1. Make sure the scale is plugged in, turned on and there is nothing on the platter.
2. Key in 9000 and press the Mode key. Display will show: P00 PROGRAM
3. Key in 111111 and press the PLU key. The display will not change.
4. Press the Enter key. Display will show: P01 PLU
5. Press the Enter key again. Display will show: P01-00 PLU >No<
6. Key in the PLU number you wish to edit and press the PLU key. Display will show: P01-01 <SALE1>
7. To Edit the PLU description:
 - a. Press the Edit key. See Figure 10-1. Display will show: INP #####-##### 00 The number before the dash is the Line and the number after the dash is the number of characters on the line.
 - b. Use the arrows keys to navigate. UP/DOWN to change lines, LEFT/RIGHT to move through the text
 - c. Use the Back Space key or Char Delete key to remove text. To remove an entire line use the Line Delete key.
 - d. For additional lines of data, press the New Line key.
 - e. When finished editing press the Enter Key

PLU (Price Look-up) Set Up

8. To change the Sales Mode from Weight to Fixed Price or vice versa:
 - a. Press the Down arrow key until the display shows: P01-01-01 SALES #
 - b. For Weighed Items key in 0 and press Enter
 - c. For Fixed Price Items key in 1 and press Enter.
9. To Edit the Price:
 - a. Press the Down arrow key until the display shows: P01-01-04 PRICE
 - b. Key in the new price (5 digit maximum do NOT include decimal) and press Enter.
 - c. To change the price of another PLU key in the PLU and press the PLU key. Key in the new price and press Enter. Repeat to edit additional PLUs
10. To Edit the Tare:
 - a. Press the Down arrow key until the display shows: P01-01-10 TARE #.###
 - b. Key in the tare weight (4 digit maximum/2 digit minimum - tare weight is a three place decimal that must end in 0 or 5) or 0 if none and press the Enter
11. To Edit the Tare Percentage:
 - a. Press the Down arrow key until the display shows: P01-01-12 P TARE #.#
 - b. Key in the new tare percentage (3 digit maximum) or 0 if none and press the Enter key.
12. To Edit the Quantity:
 - a. Press the Down arrow key until the display shows: P01-01-06 QTY #
 - b. Key in the new quantity and press Enter
13. Once you are done editing Press the Mode key. Display will show: 19001-0000 ENT OR CLR.
NOTE: Press the Enter key to save or the CLR key to cancel.
14. Press the Mode key three times to return to normal operations.

Editing PLU Dates

1. Make sure the scale is plugged in, turned on and there is nothing on the platter.
2. Key in 9000 and press the Mode key. Display will show: P00 PROGRAM
3. Key in 111111 and press the PLU key. The display will not change.
4. Press the Enter key. Display will show: P01 PLU
5. Press the Enter key again. Display will show: P01-00 PLU >No<
6. Key in the PLU number you wish to edit and press the PLU key. Display will show: P01-01 <SALE1>
7. Press the Right arrow key: Display will show: P01-06 <DATE>
8. Press the Enter key. Display will show: P01-06-01 P/D PRN #
NOTE: Select 1 for package date to appear on label or 2 to remove package date from label.
9. Key in your selection and press the Enter key.
10. Press the Enter key again. Display will show P01-06-04 SB DATE PRN #
NOTE: Select 1 for sell by date to appear on label or 2 to remove sell by date from label.
11. Key in your selection and press the Enter key.
12. Press the Enter key again. If you chose to NOT display the shelf life skip to step 14. If you chose to display the shelf life the display will show: P01-06-07 SHELF LF 1
13. Key in the number of days to expire (3 digit maximum, 1-999 days) and press the Enter key twice.
14. Press the Enter key. Display will show: P01-06 <DATE>
15. To edit addition PLUs key in the next PLU and press the PLU key. Repeat steps 7-15.
16. Once you are done editing Press the Mode key. Display will show: 19001-0000 ENT OR CLR.
NOTE: Press the Enter key to save or the CLR key to cancel.
17. Press the Mode key three times to return to normal operations.

PLU (Price Look-up) Set Up

Editing PLU Barcode

1. Make sure the scale is plugged in, turned on and there is nothing on the platter.
2. Key in 9000 and press the Mode key. Display will show: P00 PROGRAM
3. Key in 111111 and press the PLU key. The display will not change.
4. Press the Enter key. Display will show: P01 PLU
5. Press the Enter key again. Display will show: P01-00 PLU >No<
6. Key in the PLU number you wish to edit and press the PLU key. Display will show: P01-01 <SALE1>
7. Press the Right arrow key twice: Display will show: P01-07-01 CODE 00000000
8. Key in the new barcode and press Enter
9. To edit addition PLUs key in the next PLU and press the PLU key. Repeat step 8.

NOTE: The barcode can be the PLU number, which the scale defaults to, or the POS (point of sale) number. If the PLU number is to be in the barcode simply press the Enter key. If the POS number is to be in the barcode, key in the POS number (5 digit maximum) and press the Enter key. The scale can be reprogrammed to accept a 6 digit PLU or POS number. Contact Globe's Technical Service Department for assistance.

10. Once you are done editing Press the Mode key. Display will show: 19001-0000 ENT OR CLR.

NOTE: Press the Enter key to save or the CLR key to cancel.

11. Press the Mode key three times to return to normal operations.

Editing Unit Price Dates

1. Make sure the scale is plugged in, turned on and there is nothing on the platter.
2. Key in 9000 and press the Mode key. Display will show: P00 PROGRAM
3. Key in 111111 and press the PLU key. The display will not change.
4. Press the Enter key. Display will show: P01 PLU
5. Press the Enter key again. Display will show: P01-00 PLU >No<
6. Key in 999999 and press the PLU key. Display will show: P01-01 <SALE1>
7. Press the Right arrow key: Display will show: P01-06 <DATE>
8. Press the Enter key. Display will show: P01-06-01 P/D PRN #

NOTE: Select 1 for package date to appear on label or 2 to remove package date from label.

9. Key in your selection and press the Enter key.

10. Press the Enter key again. Display will show P01-06-04 SB DATE PRN #

NOTE: Select 1 for sell by date to appear on label or 2 to remove sell by date from label.

11. Key in your selection and press the Enter key.

12. Press the Enter key again. If you chose to NOT display the shelf life skip to step 14. If you chose to display the shelf life the display will show: P01-06-07 SHELF LF 1

13. Key in the number of days to expire (3 digit maximum, 1-999 days) and press the Enter key twice.

14. Press the Enter key. Display will show: P01-06 <DATE>

15. Key in 999998 and press the PLU key. Repeat steps 7-14.

16. Press the Mode key. Display will show: 19001-0000 ENT OR CLR.

NOTE: Press the Enter key to save or the CLR key to cancel.

17. Press the Mode key three times to return to normal operations.

PLU (Price Look-up) Set Up

Setting up Default PLU

NOTE: The scale is programmed to operate with the default PLU number 1. This PLU can operate with or without a product name, price and/or tare.

NOTE: When a default PLU is set up, the scale will return to the default PLU after each transaction instead of clearing to no PLU.

NOTE: The default PLU can be used to bypass entry of a PLU for each transaction.

NOTE: A different PLU may be recalled at any time to override the default PLU during normal operation.

Default PLU Activation/Deactivation

1. Make sure the scale is plugged in, turned on, and there is nothing on the platter.
2. Key in 6000 and press the MODE key. The display will show: < B00 SETUP >
3. Key in 495344 and press the PLU key.
4. Key in 17 and press ENTER display will show: < OPERATION SETTINGS >
5. Press ENTER two times display will show: < B17-01-02 OPEN PLU # >
6. Enter 1 to activate the default PLU function, or 2 to deactivate, and then press ENTER.
7. Press the MODE key three times to return to normal operations.

Operating the Default PLU

NOTE: When the scale is turned on and initialized it will not pull up the default PLU until an action is taken. i.e Entering and printing any PLU, using the Unit Price key to print a label, or changing label formats.

1. Make sure that the labels are loaded before using the scale, refer to Loading/Unloading Labels for instructions.
2. Make sure the scale is plugged in, the platter is on top of the scale, the scale is turned on and the operating keypad is placed under the plastic covering.

NOTE: The display will show all zeros except in the price area which will show 000001 when the scale is ready to use the default PLU. If the price area does not show 000001, press 1 and then the PLU key.

3. If a tare is needed, do one of the following steps:
 - a. Place the empty container on the platter and press the TARE key or...
 - b. Enter the tare amount and press the TARE key.
4. Enter the product price and press the Unit Price key.
5. Place the product on the platter. The display will show the tare, weight, unit price and total price.
6. Press the PRINT key for a label to print.

Deleting A PLU

1. Make sure the scale is plugged in, turned on and there is nothing on the platter.
2. Key in 9000 and press the Mode key. The display will show: P00 PROGRAM
3. Key in 1 and press the Enter key. Display will show: P01 PLU
4. Key in 111111 and press the PLU key.
5. Press the Enter key. Display will show: P01-00 PLU >No.<
6. Press the down arrow key two times. Display will show: P01-00 No. 1 >PL

NOTE: Use the down arrow to select the PLU number to delete.

7. Press the →0← Zero key. Display will show: 13002-0000 ENT OR CLR.

NOTE: Press the Enter key to save or the CLR key to cancel.

8. Press the Enter key.
9. Press the Mode key three times to return to normal operation.

Preset Key Set Up

Setting Up PLU Preset Keys

1. Make sure the scale is plugged in, turned on and there is nothing on the weigh platter.
2. Key in 9000 and press the Mode key. Display will show: P00 PROGRAM
3. Key in 4 and press the Enter key. Display will show: P04 PRESET KEY
4. Key in 11111 and press the PLU key. Display will show: P04 PRESET KEY
5. Press the Enter key. Display will show: P04-01 000 0 000
6. Press the desired preset key. See Figure 14-1.

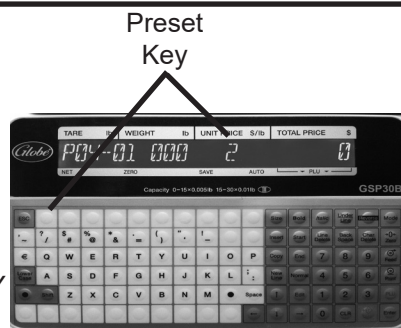


Figure 14-1

NOTE: Make sure to mark the selected preset key with the PLU name on the Operating Keysheet. See Figure 12-2.

NOTE: Two values can be stored on each preset key. The Lower Level preset function key is used to switch between upper and lower level. Refer to Operating Instructions (Function Keys).

7. Key in 1 for the preset function key flag number and press the Enter key.
8. Key in PLU number and press the desired preset key. See Figure 14-3.
9. Repeat step 5 through 8 to set up additional keys. When completed, press the Mode key three times to return to normal operation.

NOTE: In normal operation, use the Lower Level preset function key to switch between upper and lower level.

Setting Up Cassette Preset Functions Keys

NOTE: Up to seven cassette's can be programmed. Each cassette contains the label spec and label format for a label. Once you have setup the cassettes, you can change your label format by selecting the applicable cassette preset key.

1. Make sure the scale is plugged in, turned on and there is nothing on the weigh platter.
2. Key in 9000 and press the Mode key. Display will show: P00 PROGRAM
3. Key in 4 and press the Enter key. Display will show: P04 PRESET KEY
4. Key in 11111 and press the PLU key.
5. Press the Enter key. Display will show: P04-01 000 0 000
6. Press the desired preset key. See Figure 14-4.

NOTE: Make sure to mark the selected preset key with the PLU name on the Operating Keysheet. See Figure 12-2.

7. Key in 435 for the preset function key flag number and press the Enter key. Display will show: P04-01 435 74 0
8. Key in Cassette number. Press the desired preset key. See Figure 14-5.
9. Press the Mode key three times to return to normal operation.



Figure 14-2

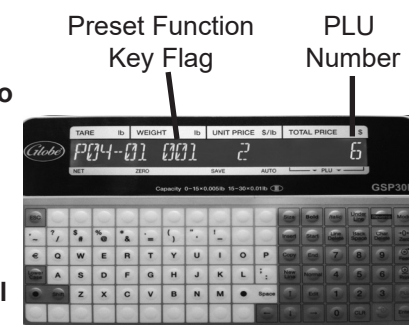


Figure 14-3

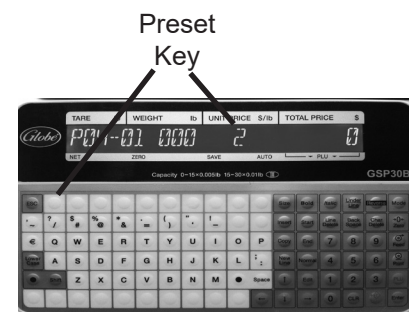


Figure 14-4

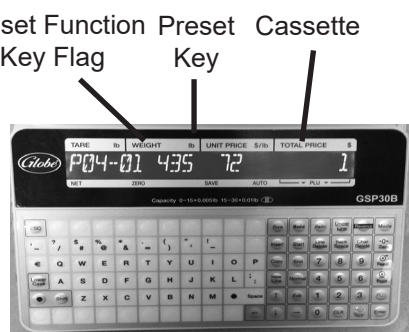


Figure 14-5

Preset Key Set Up

Setting Up Tare Preset Functions Keys

1. Make sure the scale is plugged in, turned on and there is nothing on the weigh platter.
2. Key in 9000 and press the Mode key. Display will show: P00 PROGRAM
3. Key in 4 and press the Enter key. Display will show: P04 PRESET KEY
4. Key in 11111 and press the PLU key. Display will show: P04 PRESET KEY
5. Press the Enter key. Display will show: P04-01 000 0 000
6. Press the desired preset key. See Figure 15-1.

NOTE: Make sure to mark the selected preset key with the PLU name on the Operating Keysheet. See Figure 15-2.

NOTE: Two values can be stored on each preset key. The Lower Level preset function key is used to switch between upper and lower level. Refer to Operating Instructions (Function Keys).

7. Key in 2 for the preset function key flag number and press the Enter key. Display will show: P04-01 002 "1" 0
8. Key in weight of the container. Press the desired preset key. See Figure 15-3.

NOTE: Weight of the container must be entered in 3 or more decimal places. Example, if the weight of the container is 0.5 pounds, enter 500 with no decimal places. If the weight of the container is 1.5 pounds enter 1500 with no decimal places.

9. Press the Mode key three times to return to normal operation.

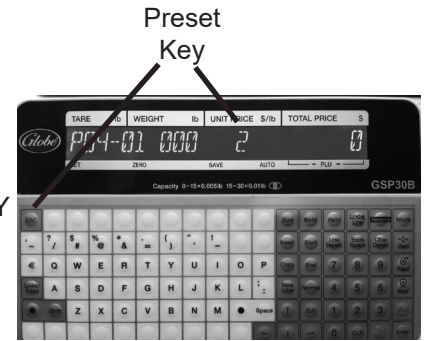


Figure 15-1



Figure 15-2

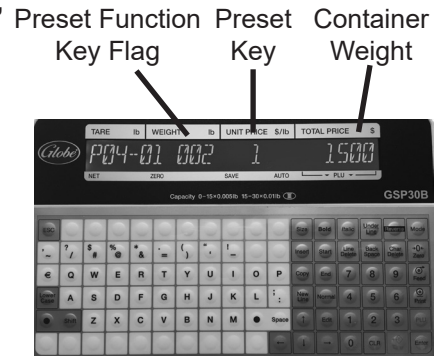


Figure 15-3

Preset Key Set Up

Setting Up Preset Function Keys

1. Make sure the scale is plugged in, turned on, and there is nothing on the weigh platter.
2. Key in 9000 and press the Mode key. The display will show: P00 PROGRAM
3. Key in 4 and press the Enter key. Display will show: P04 PRESET KEY
4. Key in 111111 and press the PLU key. Display will show: P04 PRESET KEY
5. Press the Enter key. Display will show: P04-01 000 0 000
6. Place the Operating Keysheet over the Scale Set-Up Keysheet. Press the desired preset key. Remove the Operating Keysheet and note which preset key was used.
7. Key in the desired preset function key flag number (see list below), press the Enter key.
8. Key in 0 (Warning: Press the number 0, below number 1, NOT the →0←Zero key.) and then press the preset key again to recognize the entry as the function key. Refer to Operating Instructions (Function Keys).

NOTE: Display will not change. To make sure that the preset key is set, select any other key on the scale set-up keysheet and then the desired preset key again. Display should show the selected key with the preset function key flag just keyed in.

NOTE: Two values can be stored on each preset key. The Lower Level preset function key is used to switch between upper and lower level.

Preset function key flag

PLU	1
Auto Manu	75
U/P (Unit Price)	32
Lower Level	156
Cassette Switching	435
Tare	2
Fixed Price	3
X (Multiply)	4
Special Price	5
-\$ Price Discount	6
-% Percentage Discount	7
Save	8

9. Repeat steps 6 and 8 to set up additional keys. When completed press the Mode key three times to return to normal operation.

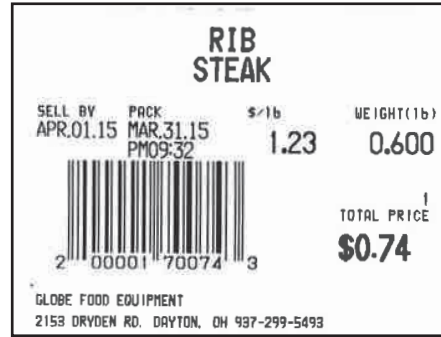
Deleting Preset Keys

IMPORTANT: This procedure will delete ALL preset keys at once!

1. Make sure the scale is plugged in, turned on and there is nothing on the weigh platter.
2. Key in 9000 and press the Mode key. Display will show: P00 PROGRAM
3. Key in 4 and press the Enter key. Display will show: P04 PRESET KEY
4. Key in 111111 and press the PLU key. Display will show: P04 PRESET KEY
5. Press the Enter key.
6. Press the →0← Zero key. Display will show 14033-0000 ENT OR CLR
Note: Press the Enter key to execute or the CLR key to stop.
7. There will be a long beep which signals that all preset keys have been deleted.
8. Press the Mode key three times to return to normal operation.

SAMPLES of all available labels for the GSP30B

1. To change to E11, press the Reverse Key (Lower Preset) and the Line Delete Key (E11) See Figure 17-1.



SAMPLE ONLY Standard GSP30B Label E11

Figure 17-1

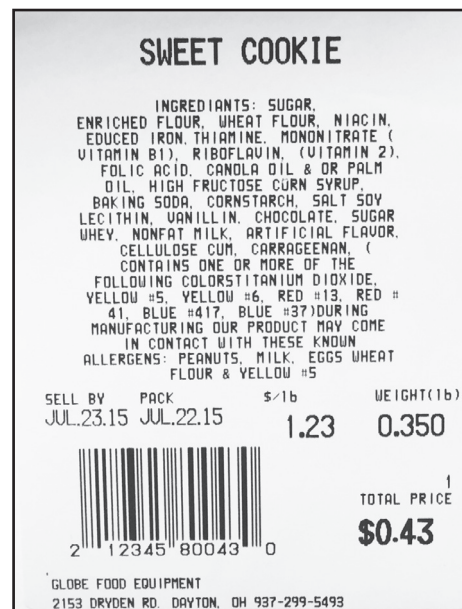
2. To Change the E12, press the Reverse Key (Lower Preset) and the Backspace Key (E12) See Figure 17-2.



SAMPLE ONLY Safe Handling GSP30B Label E12

Figure 17-2

3. To change to E13, press the Reverse Key (Lower Preset) and the Char Delete Key (E13) See Figure 17-3.



SAMPLE ONLY Ingredient GSP30B Label E13

Figure 17-3

Operating Instructions (PLU's)

Manual Label Print

1. Make sure the scale is plugged in, the weigh platter is on top of the scale, the scale is turned on.
2. Enter a PLU number and press the PLU key or press one of the PLU preset keys. The PLU information will be displayed.

NOTE: To access the lower level of preset keys, press the Lower Level preset function key and then the preset key. Refer to Preset Key Set Up.

3. If a tare weight was not programmed for the PLU and it is needed, do one of the following steps:
 - a. Place the empty container on the weigh platter and press the tare key or...
 - b. Enter the tare amount and press the tare key.

4. Place the product on the weigh platter and press the Print key for a label to print.

NOTE: If the PLU is for a fixed priced item, press the Print key for the label. Product does not have to be placed on the platter.

NOTE: The scale will go back to 0.00.

Automatic Label Print (Weighed Items)

NOTE: To print labels automatically when PLU is selected, you must first set-up the AUTO/MANU preset function key. Refer to Preset Key Set Up.

1. Press the Auto Manu preset function key.

NOTE: An arrow will show on the display pointing to the word AUTO. This indicates that the scale is in automatic label print mode.

2. Enter a PLU number and press the PLU key or press one of the PLU preset keys. The PLU information will display.
3. If a tare weight was not programmed for the PLU and it is needed, do one of the following steps:
 - a. Place the empty container on the weigh platter and press the tare key or...
 - b. Enter the tare amount and press the tare key.

4. Place the product on the weigh platter and a label will automatically print.

NOTE: While the scale is in the automatic label printing mode it will not reset to 0.00's. Continue to enter PLU numbers and weigh products.

NOTE: To stop automatic label print mode press the Auto Manu preset key. The arrow pointing to AUTO on the display will go out of view and the scale will reset to show all zeros.

Automatic Label Print (Fixed Priced Items)

NOTE: To print labels automatically when PLU is selected, you must first set-up the AUTO/MANU preset function key. Refer to Preset Key Set-Up.

1. Press the Auto Manu preset key.

NOTE: An arrow will show on the display pointing to the word AUTO. This indicates that the scale is in automatic label print mode.

2. Enter a PLU number and press the PLU key or press one of the preset keys. The PLU information will be displayed.
3. Enter the number of labels you want printed for this item and press the Print key. The number of labels entered will be printed automatically one after the other.

NOTE: If you press the Print key without entering a number first, the scale will continue to automatically print labels until the Print key is pressed again.

NOTE: To stop automatic label print mode, press the Auto Manu preset key. The arrow pointing to AUTO on the display will go out of view. Press the Mode key to return to normal operation.

Operating Instructions (Function Keys)

Using Function Keys

NOTE: Function keys must first be set up as preset keys. Refer to Preset Key Set Up.

PLU - Used to select a PLU preset function key.

1. Press the PLU preset function key.
2. Place the item to be weighed on the scale.
3. Press the Print key to issue a label.

Auto Manu - Used to print labels automatically.

NOTE: Make sure to change the Auto Manu preset key to MANUAL before selecting a fixed price, multiple, special price, -\$ price discount or -% percent discount preset function key. Labels will not print with the updated price if the scale is set to AUTO.

1. Key in the PLU and press the PLU key
2. Press the Auto Manu preset key. The auto indicator on the display will be lit.
3. Press the Auto Manu preset key. The auto indicator on the display will go off.
4. Press the Mode key to return to normal operation.

Unit Price - Used to print labels without the use of a PLU.

1. Place product on the scale.
2. Enter the unit price and press the Unit Price preset key.
3. Press the Print key two times.

Lower Level Preset Keys - Used to select lower level preset keys.

1. Press the Lower Level preset function key to select a PLU preset key or preset function key.
2. Press the PLU preset key or preset function key.

NOTE: The scale will return to the upper level preset keys after the product has been weighed and label has printed.

Cassette Preset Keys - Used to select label formats within a specified cassette.

1. Press the Lower Preset key.
2. Press the Cassette preset function key.

NOTE: Scale will beep two times to indicate Cassette has changed.

Tare - Used to find the weight of an empty container.

1. Key in the PLU and press the PLU key or press one of the PLU preset keys.
2. Press the Tare preset key.
3. Press the Print key to issue a label.

Operating Instructions (Function Keys)

Fixed Price - Used to temporarily change the selling price for a fixed price item.

1. Key in the fixed priced PLU and press the PLU key or press one of the PLU preset keys.
2. Key in the temporary price.
3. Press the fixed price preset key.
4. Press the Print key to issue a label.

Multiple - Used to price multiple pieces of an item (fixed price items).

1. Key in the fixed priced PLU and press the PLU key or press one of the PLU preset keys.
2. Key in the quantity.

NOTE: Maximum 99 pieces.

3. Press the Multiple preset key.
4. Press the Print key to issue a label.

Special Price - Used to temporarily reduce the selling price.

1. Key in the PLU and press the PLU key or press one of the PLU preset keys.
2. If the PLU is a fixed price item, continue with step 3. If the PLU is a weighed item, place the product on the weigh platter so a total price is displayed.
3. Key in the special price.
4. Press the Special Price preset key.

NOTE: The display will not change; however, when the label prints, it will show the special price.

5. Press the Print key to issue a label.

-\$ Price Discount - Used to temporarily subtract an amount from the total price.

1. Key in the PLU and press the PLU key or press one of the PLU preset keys.
2. If the PLU is a fixed price item, continue with step 3. If the PLU is a weighed item, place the product on the receiving tray so a total price is displayed.
3. Key in the dollar amount to be discounted.
4. Press the -\$ Amount Discount preset key.

NOTE: The display will not change; however, when the label prints, it will show the discounted price.

5. Press the Print key to issue a label.

-% Percent Discount - Used to temporarily subtract a percentage from the total price.

1. Key in the PLU and press the PLU key or press one of the PLU preset keys.
2. If the PLU is a fixed price item, continue with step 3. If the PLU is a weighed item, place the product on the receiving tray so a total price is displayed.
3. Key in the percent amount to be discounted (3 digit maximum do NOT include decimal).
4. Press the % Percent Discount preset key.

NOTE: The display will not change; however, when the label prints, it will show the discounted price.

5. Press the Print key to issue a label.

Save - Used to maintain the called up PLU data.

1. Key in the PLU and press the PLU key or press one of the PLU preset keys.
2. Press the Save preset key. The save indicator on the display will be lit.
3. Press the Save preset key again to release the PLU data. The save indicator on the display will go off.
4. Press the Mode key to return to normal operation.

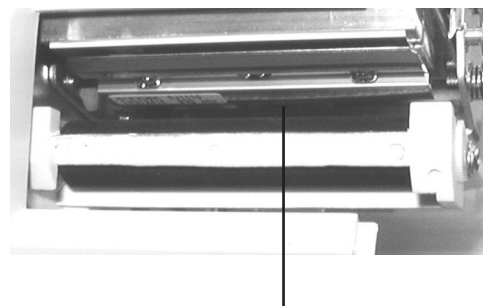
Cleaning/Maintenance

Cleaning

- Disconnect the power supply before cleaning.
- Keep the machine and Operator Keysheet free of dust and dirt.
- Make sure that all spills are wiped clean, especially on the weigh platter.
- Do not put components in dishwasher.
- Dilute detergent per supplier's instruction.
- Do not hose down or pressure wash any part of the scale.
- Never use a scrubber pad, steel wool, or abrasive material to clean the scale.
- Clean the scale with a mild detergent and warm water solution.
- Do not allow moisture to get into the load cell mounted under the scale weigh platter. Water damage is not covered under the limited warranty.
- When cleaning the scale, only use a soft, damp cloth with a mild cleaner. Never use volatile or caustic liquids.

Cleaning the Print Head

1. Dip a cotton swab into the thermal print head cleaning solution provided with the scale. Isopropyl rubbing alcohol can also be used.
2. Rub the cotton swab on the print head until debris is removed.
3. Allow the alcohol to air dry.



Thermal Print Head



DO NOT use cloth or other material to dry the print head. This can possibly damage the print head.



If labels have become stuck to print head, **NEVER** use any sharp or metal object to scrape labels from print head. Doing so will damage the print head.

Maintenance

It is recommended that the following steps be performed on a daily basis:

1. Make sure that there is a sufficient amount of labels remaining in the machine.
2. Clean the thermal head with a cotton swab, thermal head cleaning solution or isopropyl rubbing alcohol only.

Troubleshooting

Scale will not light up.

1. Check to make sure wall outlet has power to it.
2. Check and make sure power cord is plugged in.
3. Turn scale on by pushing the power switch on the left side of the scale.
4. Call for service.

Scale lights up but all functions are inoperable (locked up).

1. Unplug scale from wall outlet, wait 10 seconds, plug scale back in. Turn the scale on by pushing the power switch on the left side of the scale.
2. Call for service.

Scale not weighing properly.

1. Make sure scale weigh platter is mounted to scale properly.
2. Check to make sure nothing is touching weigh platter. If anything touches the platter it will affect the weight display.
3. Tare is improperly set.
4. Call for service.

Labels are automatically printing when an item is placed on the weigh platter.

1. The machine is set in automatic mode. Press the AUTO MANU preset key to switch the scale back to manual mode. The AUTO indicator will go out of view.

Labels will not come out when print key is pushed.

1. Make sure labels are properly installed. Refer to Loading/Unloading Labels.
2. Make sure labels have not stuck to print head area.
3. Check the weight of the item, it must be 0.100lbs or more.

Multiple Labels come out, followed by the 1011 error code.

1. Make sure labels are properly installed. Label must be lined up before the print head. Refer to Loading/Unloading Labels.
2. Make sure print head is pressed down.
 - a. Release the printer head by pushing the release lever down.
 - b. Push down on the lock lever until the print head locks into position.
3. Make sure correct cassette is selected for the label size that is loaded.



If labels have become stuck to print head, **NEVER** use any sharp or metal object to scrape labels from print head. Doing so will damage the print head. Refer to Cleaning/Maintenance.

Print on labels is not clear.

1. Refer to Cleaning/Maintenance.

Error Messages

When an error occurs, the scale will beep rapidly five times and display an error code followed by ENT. To clear the error, press the Enter button.

**NOTE: If error message on display is not included in the list below, contact Globe Food Equipment.
866-260-0522**

0312-0000	Label is remaining
0316-0000	Special price entered is equal to or over the preset PLU price
0396-0000	No USB found
1010-0000	Scale is out of labels
1011-0000	The label is not in the proper position. Refer to Loading/Unloading Labels
0713-0128	Too many characters in the store address. Max one line, 48 characters
0713-0130	Too many characters in the store name. Max one line, 48 characters
0713-0132	Too many characters in the product description. Refer to PLU Setup
15029-0001	Power scale off then turn scale back on.

Tare Weight

Tare is the weight of an empty container. Tare is used to weigh food by removing the weight of the container, plate or bowl so you are left with just the food weight.

EXAMPLE 1:

If your cafe has a sundae bar and the sundae bar is sold by weight, you can set up the PLU to subtract the weight of the sundae dish so the customer is paying for only the net weight of the sundae.

EXAMPLE 2:

Potato Salad is sold in a plastic container. The weight of the container can be programmed into the PLU so that the container weight will automatically be deducted each time the product is weighed.

NOTE: There are three different ways to manage the Tare Weight of a container.

1. Key in a PLU number or select a PLU preset key.
 - a. Place the container on the weigh platter and select the Tare key on the Operator Keysheet.
 - b. Add the product on the weigh platter and press the Print key.
2. Program a Tare preset key. Refer to Preset Key Set Up.
3. Use the ScaleLink Pro 5 Lite Software to set up the Tare preset key. Refer to Edit Keyboard Layout, in the ScaleLink Pro 5 Lite Software User Guide for setup information.

USB Scale Backup and Restore

NOTE: Data folders are used to store/restore the scale backup information PLUs, store information, label formats ect. Up to 7 data folders can be used to store/restore the backup information of the scale.



If a Data01, 02, 03 ect. folder exists on the USB device and the same data folder is selected to store the backup information, the previous backup information will be overwritten.

Scale to USB

Scale to USB is used to backup a configuration file to an USB device.

1. Make sure the scale is plugged in, the weigh platter is on top of the scale, the scale is turned on.
2. Key in 6000 and press the Mode key. Display will show: B00 SETUP
3. Key in 495344 and press the PLU key.
4. Key in 27 and press the Enter key. Display will show: B27 FILE SAVE/LOAD
5. Press the Enter key. Display will show: B27-01 <USB-TO-SCALE>
6. Press the right arrow key on the Scale Set-Up Keysheet. Display will show: B27-02 <SCALE-TO-USB>
7. Press the Enter key. Display will show: B27-02-01 O/P SELECT >PL

NOTE: Make sure USB device is installed in the USB port.

8. Press the PLU key. Display will show: B27-200 SEL USB FOLDER
9. Use down arrow key on the Scale Set-Up Keysheet to select the folder that the data will be stored in (e.g. Data 01, 02, 03 ect.). Press the PLU key. Display will show: B27-02 <SCALE-TO-USB>

NOTE: Scale will pause. After about five seconds backup will begin.

10. Press the down arrow key on the Scale Set-Up Keysheet two times. Display will show: B27-02-02 DATA TYPE 1
11. Key in 1 then press the Enter key.
12. Press the down arrow key on the Scale Set-Up Keysheet once. Display will show: B27-02-03 MASTER MODE 2
13. Key in 1 then press the Enter key.
14. Press the down arrow key on the Scale Set-Up Keysheet once. Display will show: B27-02-04 EXECUTE >ZR
15. Press the →0 Zero key←. Display will show: 14011-0000 ENT OR CLR

NOTE: Select Enter key to continue or CLR key to cancel the backup.

16. Press the Enter key.

NOTE: Scale will pause. After about five seconds backup will begin.

17. Display will show: 14014-0000 ENT

NOTE: Scale backup was successful and is now stored on the USB.

18. Remove USB device from scale.
19. Press the Mode key four times to return to normal operation.
20. Install USB device into the USB port on PC to read backup information.

NOTE: Data will be stored in the “Data01” folder that was selected above.

USB to Scale

USB to Scale is used to restore a configuration file from an USB device to the scale.

1. Make sure the scale is plugged in, the weigh platter is on top of the scale, the scale is turned on.
2. Key in 6000 and press the Mode key. Display will show: B00 SETUP

USB Scale Backup and Restore

3. Key in 495344 and press the PLU key. Display will show: B00 SETUP
4. Key in 27 and press the Enter key. Display will show: B27 FILE SAVE/LOAD
5. Press the Enter key. Display will show: B27-01 <USB-TO-SCALE>
6. Press the Enter key. Display will show: B27-01-01 I/P SELECT >PL
NOTE: Make sure USB device is installed in the USB port.
7. Press the PLU key. Display will show: B27-100 SEL USB FOLDER
NOTE: Scale will pause while reading USB.
8. Use the down arrow key on the Scale Set-Up Keysheet to select the data folder (e.g. Data 01, 02, 03 ect.) to restore USB backup data. Press the PLU key. Display will show: B27-01 <USB-TO-SCALE>
9. Press the down arrow on the Scale Set-Up Keysheet two times. Display will show: B27-01-03 MASTER MODE
10. Key in 1 and press the Enter key.
11. Press the down arrow key once. Display will show: B27-01-04 EXECUTE > ZR
12. Press the →0 Zero key←. Display will show: 14011-0000 ENT OR CLR
NOTE: Select Enter key to continue or CLR key to cancel the restore.
13. Press the Enter key.
NOTE: Scale will pause. After five seconds data folder from USB will begin to be upload to scale. Display will show the update in progress.
14. Display will show: 14013-0000 ENT
NOTE: Restore was successful and the data folder selected from the USB has been uploaded to the scale.
15. Remove USB device from scale.
16. Press the Mode key four times to return to normal operation.

Additional Features

Additional features are available for the GSP30B scale with the ScaleLink Pro 5 Lite (SLP-V Lite) software. The software is a PC provided program for creating, storing, and organizing your Ingredients Labels (for E13 labels only). This optional accessory is available for download at www.GSP30B.gfesupport.com with the purchase of this scale. Please contact a local Globe Representative for more information regarding this software.

SLP-V Lite Software Features

- Scale data maintenance (Add/Edit/Delete information)
- Production total report
- Text import/export
- Scales campaign, Batch price change
- Scheduling functions, etc.
- Label format edition
- Logo image registration
- Supports multiple logos for each PLU
- Various character sizes that can be freely italicized, underlined, reversed and bolded
- Scale status monitoring illustrations memory capacity, thermal head status, and more.
- Error reports at scale
- Data and scale configuration backup/restore
- Scale firmware upgrades for up-to-date scale operating system
- Quick price and markdown change feature

