

# ICE MAKER USER MANUAL

MODEL : IM-1106-WC/H

- ※ This machine cannot be used in any other country where the electric voltage for its power supply is not available.
- ※ This product is designed for indoor installation. Please be sure to install it indoors.
- ※ The external appearance, design, color, and/or components of this machine may be changed without prior notice for the sake of the Company's product manufacture.
- ※ For maximum hygiene, be sure to clean and sterilize the product on a daily basis.

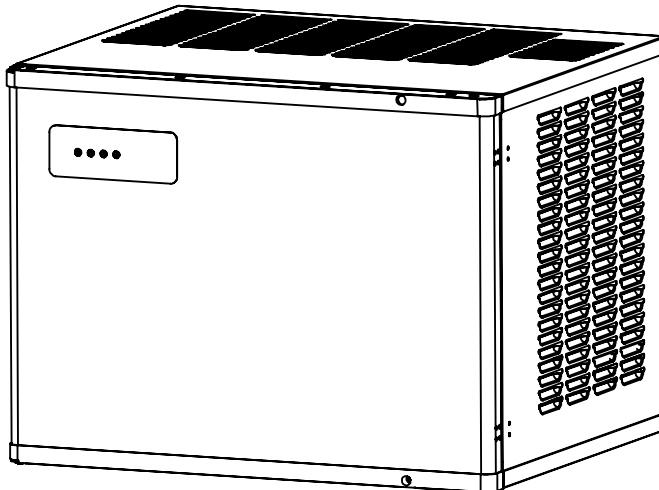



# INDEX

---

---

1. Preparations for safety · .....	3~12
2. Specifications .....	13
3. Part names .....	14
4. How to install .....	15~23
– Suitable installation condition and place	
– Installation Conditions	
– Line set installation	
– How to install the storage bin	
– How to Remove Panel	
– Installing the ice maker and connecting storage bin	
– How to Connect Water Supply and Drain	
– Electrical Connection	
– After Installation	
5. Operation Guide .....	24~26
– ICE MAKING	
– WASH	
– OFF	
– Adjusting Ice Thickness	
6. Operating Status Display .....	27~29
– Operating Status Display	
– Display of Flexible Numeric Display (FND) Module	
– Display and How to Use	
7. Removal from Service/Winterization .....	30
– Air-Cooled ICE MACHINES	
– Water-cooled ICE MACHINES	
8. Maintenance, Repair, and Disinfection .....	31~36
– Disassembling Parts for Washing and Disinfection	
– Cleaning and Disinfection	
– Precautions for cleaning	
– Cautions for cleaning the external panel(stainless steel)	
9. Types of Product Error .....	37
10. Before Contacting Service Center .....	38~40

# 1. Safety Preparations

 <b>Warning</b>	Failure to follow these instructions may result in severe personal injury or death.
 <b>Caution</b>	Failure to follow these instructions may result in parts replacement expense and / or service repair expense.



SHOULD BE DONE



PROHIBITION



DO NOT  
DISASSEMBLE



DO NOT  
TOUCH



DISCONNECT  
POWER PLUG



GROUNDED

## Warning

### Use a single receptacle of the ice machine

- ◆ An electrical fire may be caused by a receptacle holding more than one item.
- ◆ Do not use an adapter or an extension cord.

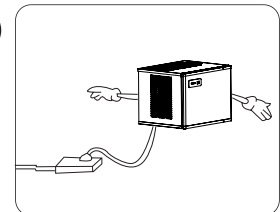

### Clean the plug

Clean the plug, if covered in foreign material or dust etc. with a clean, dry towel.

- ◆ A fire may occur if plug is not clean.

### All wiring must conform to local, state and national codes.

The wire size (or gauge) is dependent upon location, materials used, length of run, etc., so it must be determined by a qualified electrician.

### MINIMUM POWER CORD SPECIFICATIONS

Maximum Breaker Size	Minimum Wire Size	Maximum Length of Power Cord
15 amp	14 gauge	6 feet (1.83 m)
20 amp	12 gauge	6 feet (1.83 m)
30 amp	10 gauge	6 feet (1.83 m)



## Warning

Do not place or store heavy items on the top of the product.

- ◆ Damage by excessive weight can cause the unit to overheat and/or fire.

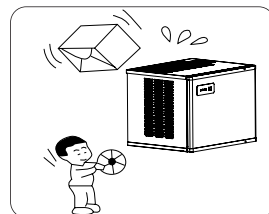

Do not install the machine under humidity area or near the area where water could spatter.

- ◆ Lack of insulation causes an electric leakage, shock and fire.

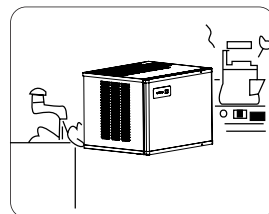

Stop operation

When the smell of burning or smoke is emitted from the machine, or if the product malfunctions, immediately unplug the product and stop operation.

- ◆ Operating the product under bad conditions may cause fire or electric shock.

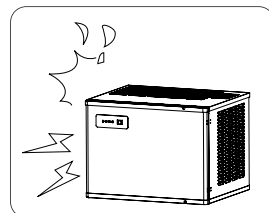

Prohibition of use:

Do not use flammable gas near the icemaker.

- ◆ It may cause explosion and fire.

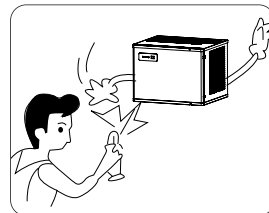

Prohibition of use:

Replace or tighten the receptacle if it is loose.

- ◆ An electric short or fire can occur.



## Warning

**Do not disassemble**

**Do not modify the parts of icemaker, and repair without an authorized person**

- ◆ It may cause the fire or extraordinary operation, and would result in the serious problem.

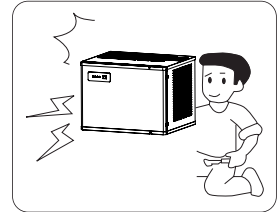

**Prohibition**

**Do not bend the power cord severely, or allow it to be pressed by a heavy matter, which can cause damage to the cord.**

- ◆ There is a danger of a current leak, electric shock and/or fire
- ◆ Be sure to contact the customer service center if the power cord or plug gets peeled or damaged.

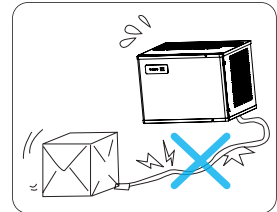

**Prohibition**

**Do not let children hang on the door of the icemaker.**

- ◆ Injury to the child or damage to the icemaker may occur.
- ◆ Let them avoid hanging onto the front door of the model when it is open.

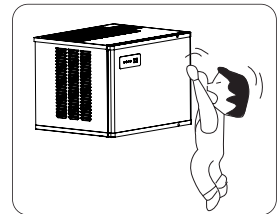

**Do not touch**

**Do not touch or disconnect the power cord with wet hands.**

- ◆ It may cause an electric shock.

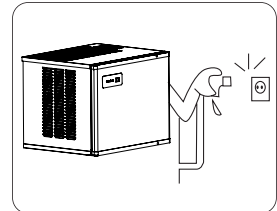

**Do not touch**

**Do not clean the inside the ice maker with sharp tools.**

- ◆ It may cause the damage of colling system ice storage part or electrocution.

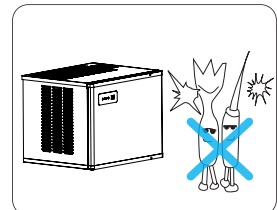



## Warning

### Disconnect power plug

For long term usage interruption or product shut-down, close the water supply valve, remove the ice from the product and unplug the power cord.

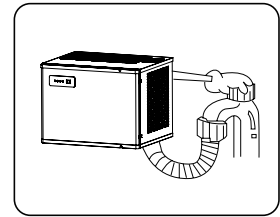

### Disconnect power plug

Unplug the power cord first when cleaning or servicing.

◆ It may cause electric shock, fire, or injury.

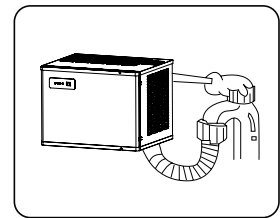

### Disconnect power plug

Separate the power plug from the receptacle with holding the plug body.

◆ Pulling the power cord or using a screwdriver to unplug may cause fire or electric sparks.

### Grounded

The Ice Machine must be connected to a GFCI receptacle or a GFCI circuit

◆ An ungrounded circuit may cause product failure or an electric shock.

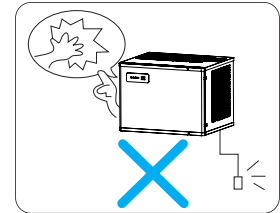

### Power strip use

Make sure the power strip supports higher power than 250V and 16A.

◆ Using multiple appliances on one power strip may cause fire. Thus, be sure to plug only one appliance especially when using this product.

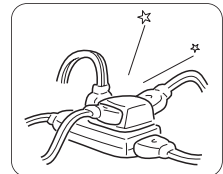

### Installing the product

When installing the product on the storage bin, use an appropriate lifting system or 2~3 men to lift the product.

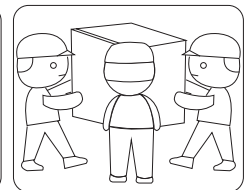

◆ Depending on the product installation space, service may not be available or additional costs may occur.



## Warning

If the earth leakage breaker is in the 'OFF' position do not turn it to the 'On' position by force.

- ◆ If you turn it 'ON' while the machine is defective, fire or electric shock may occur.

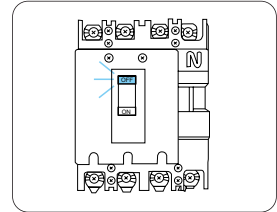

If the power cable needs replacement or repair, call a service center or an expert.

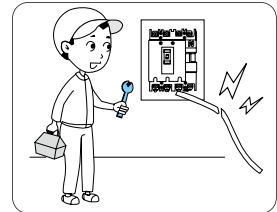

If you want to leave it unused for a long time, then close the water supply valve and turn off the earth leakage circuit breaker.

- ◆ Injury may occur if it falls over.

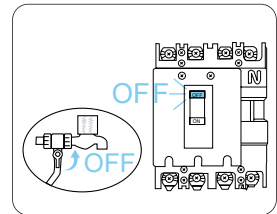

If there is water inside the power supply, turn off the earth leakage circuit breaker and dry it before use.

- ◆ It can cause electrical shocks or fire.

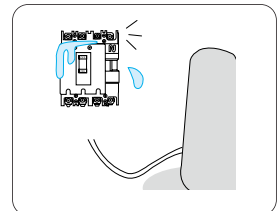

Do not place candle lights or cigarettes light on top of the product.

- ◆ It can cause fire.

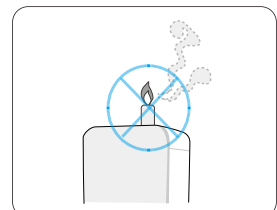



## Warning

**Do not put anything on the product.**

◆ Injury may occur if it falls over.

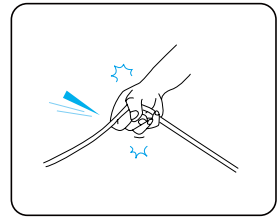

**Do not arbitrarily connect the power cord or process it for use.**

◆ It can cause fire.

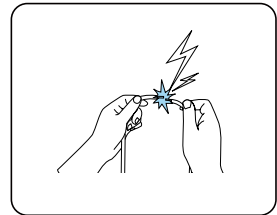

**Do not turn the power ON/OFF with the circuit breaker continuously.**

◆ It can cause electrical shocks or fire.

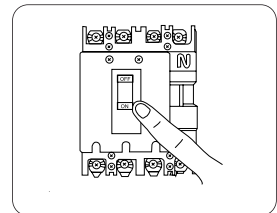



## Warning

The ice machine must be grounded in accordance with national and local electrical codes.

## About Grounding

※ Be sure to ground the product to prevent electric shock.

⦿ **Grounding method – When there is a grounding terminal**

In case of plugging the icemaker into an outlet equipped with a grounding terminal, extra grounding is unnecessary.

⦿ **Grounding method – When there is no grounding terminal**

In case of plugging the icemaker into a power outlet without a grounding terminal, connect the ground wire to the copper plate and then bury it under the ground.

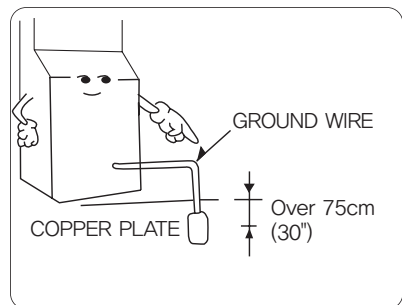

Do not ground the product on the following:

Gas piping, water supply, lightning rod, telephone line, or any connection part

※ Plastic water piping or insulated material will not provide a grounding effect.

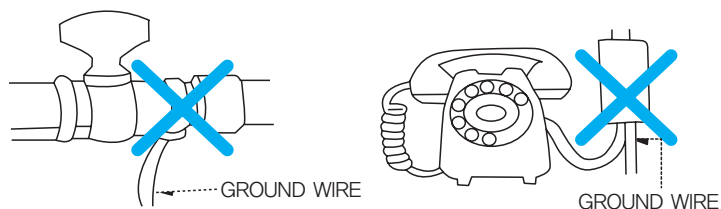



## Warning

### Electrical Connection (Junction box type)

- Electrical connection must be hard-wired and must meet national, state, and local electrical code requirements. Failure to meet these code requirements could result in death, electric shock, serious injury, fire, or damage.
  - The icemaker requires an independent power supply of proper capacity. See the nameplate for electrical specifications. Failure to use an independent power supply of proper capacity can result in a tripped breaker, blown fuse, damage to existing wiring, or component failure. This could lead to heat generation or fire.
  - **THE ICEMAKER MUST BE GROUNDED.** Failure to properly ground the icemaker could result in death or serious injury.
  - Electrical connection must be made in accordance with the instructions on the "WARNING" tag.
- Usually an electrical permit and services of a licensed electrician are required.
  - The maximum allowable voltage variation is  $\pm 10$  percent of the nameplate rating.
  - On single phase models, the green/yellow lead must be connected to the neutral conductor of the power source. **NOTICE! Miswiring may result in damage to the icemaker.**
  - The opening for the power supply connection is 7/8" DIA to fit a 1/2" trade size conduit.



## Warning

### ELECTRICAL CONNECTION THIS UNIT MUST BE GROUNDED

Failure to properly ground or wire this unit could result in death, serious injury, or severe damage to the icemaker. The white lead must be connected to the N of the power source. See diagram below.

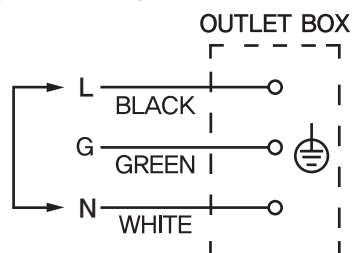



## Warning

- This unit contains R-290 which is a flammable hydrocarbon. It is safe for regular use. Do not use sharp objects to expedite defrosting. Do not service without consulting the “R-290 Handling” Section included in the User Guide. Do not damage the refrigerant circuit.
- Before you throw away your old appliance, take off the doors and leave cases in place so children may not easily climb inside.
- This appliance uses flammable gas cyclopentane as a blowing agent for its insulation. Please check and obey all federal, state, and local regulations regarding the environmentally safe disposal of this product.



## Warning

Service must be done by factory authorized service personnel. Any parts shall be replaced with like components. Failure to comply could increase the risk of possible ignition due to incorrect parts or improper service

This appliance is not intended for use by persons (including children) with reduced physical, sensory or mental capabilities, or lack of experience and knowledge, unless they have been given supervision or instruction concerning use of the appliance by a person responsible for their safety.

Children should be supervised to ensure that they do not play with the appliance.

The new hose-sets supplied with the appliance are to be used and that old hose-sets should not be reused.



## Caution

### Caution

Remove any moisture oil, anything that may cause slipping on the ground near the product.

- ◆ Slipping and hitting the ice maker or sticking one's hand or foot into the bottom will cause injury.

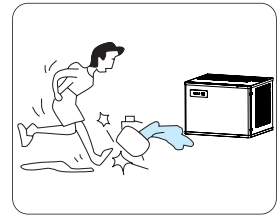

### Hand over

As you turn over the icemaker to the other user, please turn over the operation manual together.

- ◆ Be sure to refer to the user manual for the safest usage by users who are not familiar with the product.

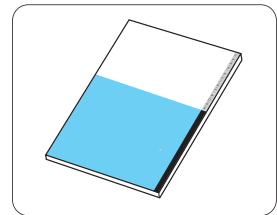

Do not slide hands or feet in under the icemaker.

- ◆ The bottom of this product has various parts including metal sheet, which may cause injury.

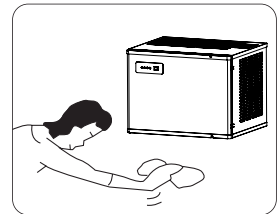

When reconnecting the power cord after disconnection, wait at least 5 minutes before reconnecting.

- ◆ Plugging in right away may cause overload and malfunction.

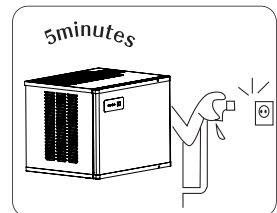

This product senses ice with voltage (resistance); since ice made of distilled water may not be recognized, tap water is highly recommended.



For areas where water contains much calcareous sediments, be sure to install a calcium filter at the water inlet port (calcium may reduce the lifecycle of the product).

## 2. Specifications

ITEM		UNIT	SPECIFICATIONS	
Model			IM-1106-WC	IM-1106-WH
Shape of Ice			Full Cube	HALF
Size	mm		22 x 22 x 22	9,5 x 29 x 22
	inch		0.86 x 0.86 x 0.86	0.37 x 1.14 x 0.86
Number(EA)			418	612
※ Maximum Manufacturing Capacitor		kg/day	474 ± 10%	
		lb/day	1,045 ± 10%	
Storage (Option)	Storage Capacity	kg	IB-033 : 160, IB-044 : 200	
		lb	IB-033 : 350, IB-044 : 440	
※ ※ Size (W X D X H)		mm	Ice Maker : 762 X 630 X 770 Ice Maker + Bin(IB-033) : 763 X 870 X 1,900 Ice Maker + Bin(IB-044) : 763 X 870 X 2,100	
		inch	Ice Maker : 30 X 24.8 X 30.3 Ice Maker + Bin(IB-033) : 30 X 34.3 X 74.7 Ice Maker + Bin(IB-044) : 30 X 34.3 X 82.6	
Power Supply			AC 220 V 60 Hz, 1 PH	
Current Consumption			11.2 A	
Weight	Before Being Packaged	kg	98 ± 5	
		lb	216 ± 10	
	After Being Packaged	kg	113 ± 5	
		lb	249 ± 10	
Compressor			1.5 HP	
Condenser			Water-Cooled	
Refrigerant			R-449A	
Water Adjust Valve Setting Value			270 psi	
Operating temperature	Temperature of supplied water	°C	10 ~ 32	
		°F	50 ~ 90	
	Ambient temperature	°C	10 ~ 38	
		°F	50 ~ 100	
	Water pressure	MPa	0.1 ~ 0.5	
		psi	14 ~ 71	

※ The condenser water flow is to be maintained at 27°C inlet and 241 kPa.

※ The maximum production calculated is based on ambient temperature and water temperature of 10°C(50°F).

There may be deviations depending on the installation conditions, which may get severe during high temperature periods such as summer.

※ ※ Be sure to check the specifications before purchasing the product since the dimensions may vary depending on the specifications of the storage bin.

※ ※ If the drain time is lengthened, the amount of ice is reduced, but clear ice can be obtained.

### 3. Part names – Water-Cooled

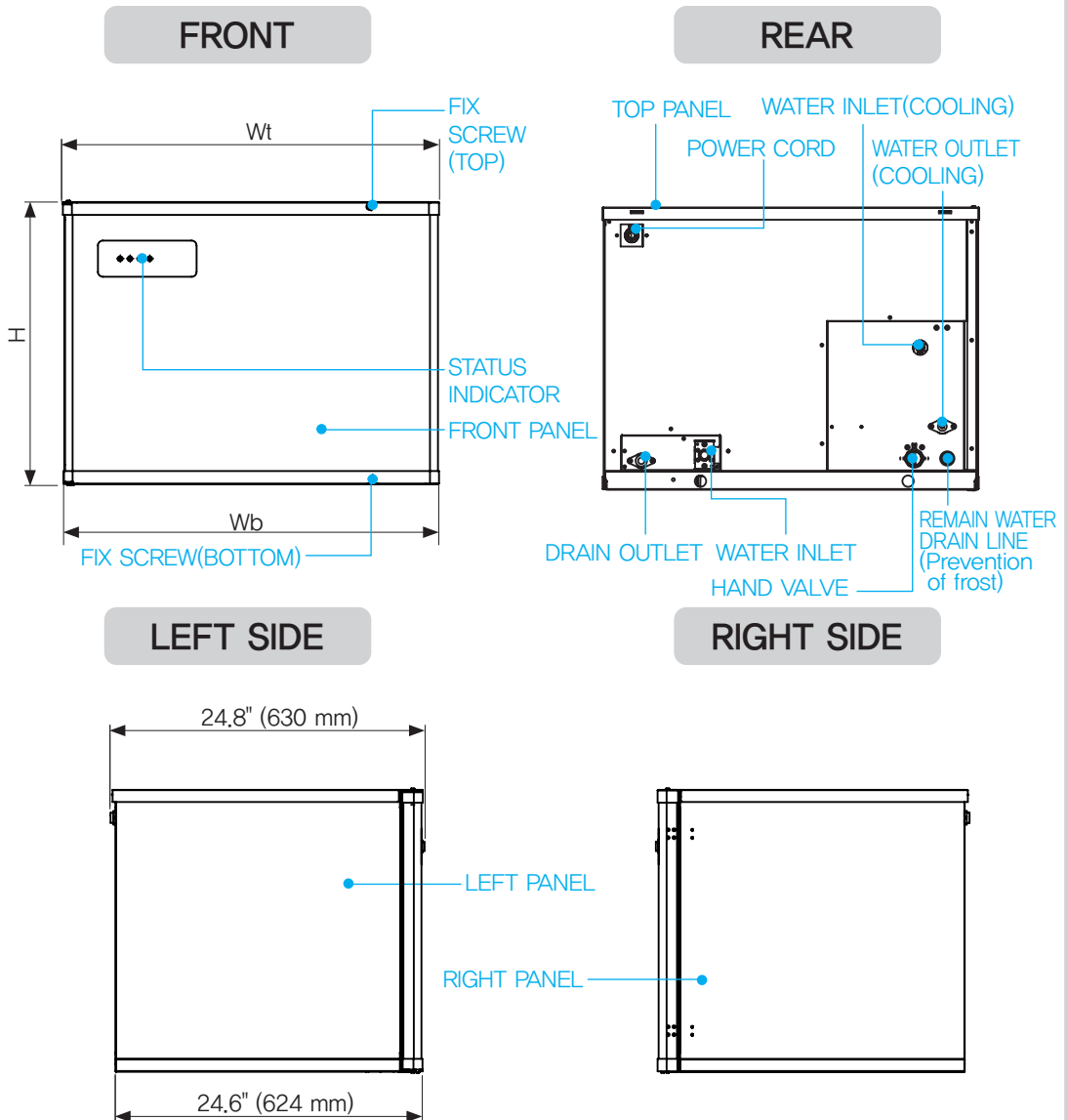

MODEL	Wt (mm)	Wb (mm)	H (mm)
IM-0465-WC/WH IM-0555-WC/WH	30" (763)	30" (762)	22.6" (573)
IM-1105-WC/WH IM-1106-WC/WH	30" (763)	30" (762)	30.3" (770)

# 4. How to install

## Suitable installation conditions/location

● Places without heat sources

- ◆ The product has to be installed at places without a heat source such as stove or gas range or any place that is out of the range of the ambient temperature (10 ~ 38°C, 50~100°F).

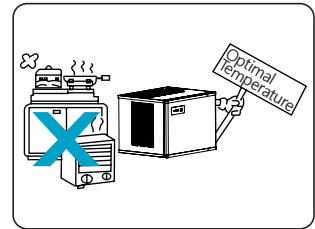

● Places with enough spaces from the walls  
Clearance Requirements

Top	Back	Sides
45cm (18")	30cm (12")	20cm (8")

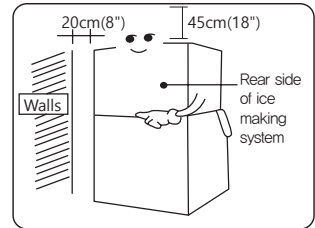

● Places with good ventilation

- ◆ Inadequate ventilation will lead to poor ice-making capability

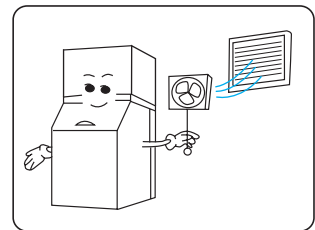

● On even surfaces

- ◆ Uneven surface will result in too much vibration or noise. (The surface angle must be less than 1°)
- ◆ Installing the product on an uneven surface may cause it to fall or slip and cause injury. Make sure that the product is installed on an even surface.

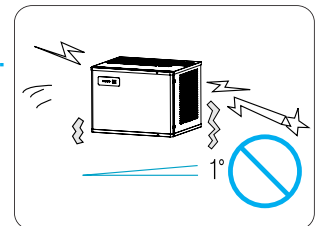

Warning

•Keep clear of obstruction all ventilation openings in the appliance enclosure or in the structure for building-in.

- Do not use mechanical devices or other means to accelerate the defrosting process, other than those recommended by the manufacturer.
- Do not use electrical appliances inside the food/ice storage compartments unless they are of the type recommended by the manufacturer.

## Suitable installation conditions/location

⦿ Be sure to install the product in clean places.

- ◆ Ice will be used for food or human consumption.  
Thus, the installation site must be clean and hygienic.

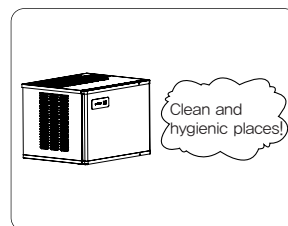

⦿ The product must be installed indoors.

- ◆ The outlet of the drain hose has to face downward to enable smooth draining.
- ◆ The product must not be installed outside.

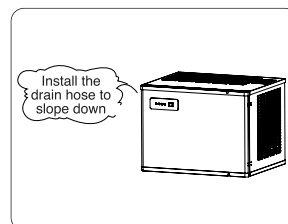

⦿ In a place inaccessible to children.

- ◆ Please pay proper attention to the safety of children; make sure that no one plays with the blade of the ice making part.

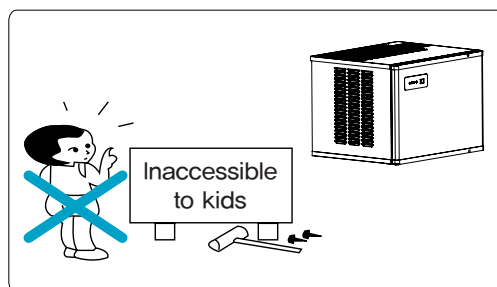

◆ Make sure to observe the following.

- Since the product makes use of water, proper water supply and draining facility are required.
- Water may leak during installation or operation for diverse reasons.  
Thus, proper draining must be prepared.

Since there is danger of electric shock due to moisture from leak, be sure to observe the following:

1. When installing the product indoors, be sure to have a natural drainage facility and make the floor waterproof, especially if the floor may get damaged due to leak.
2. A draining outlet must be available at the installation site; be sure to connect the drain hose.
3. Make sure that the floor is sloped so that any leaked water gets drained away even if the drain hose gets dislodged or damaged. Install a water overflow prevention wall to prevent damage.



- ※ Adjust the height by turning the footing if the floor is sloped to set it stably.
- ※ The manufacturer will not be liable for any problem arising from failure to comply with the warnings above, dislodged / damaged water supply hose, or inappropriate drain facility.

---

---

## How to install the storage bin

1. Unpack the ice storage bin and make sure that it will not be moved after installation.
2. Connect the drain hose at the bottom outlet part and fully tighten the joints at the connecting part in order to minimize leaks.



Tighten the joints at the connecting part, face the outlet of the hose upward, and pour some water into the bin to check for leaks.

3. Adjust the 4 adjustment feet of the storage bin to level it.  
(Adjustment must be less than 1° for all 4 feet)

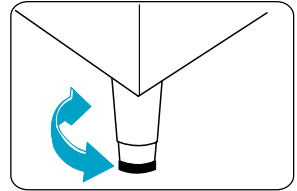

## How to Remove Panels

1. Front Panel: Loosen the top and bottom screws on the front panel and open the front panel.
2. Top Panel: Lift up the front side of the top panel slightly and push toward the rear side to remove.
3. Side Panel (Right): Loosen the screw on the front side, and remove the panel by pulling to the front and pushing upward a little.
4. Side Panel (Left): Press the pin on the bottom left side of the front panel and open the panel completely (180 °)  
Loosen the screw on the front side, and remove the panel by pulling to the front and pushing upward a little.

※ Assembly in the reverse order of disassembly.

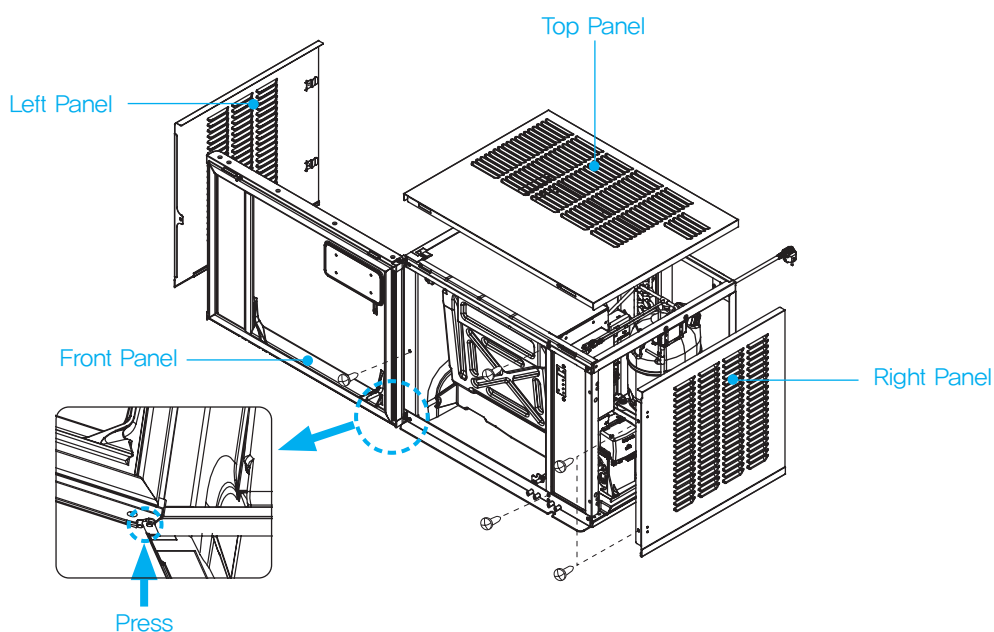

## Installing the ice maker and connecting storage bin

1. Use the lifting device to put the ice maker on top of the bin. Otherwise, at least 2 to 3 persons must work together to put the ice maker on the bin.

◆ Be sure to apply more power to the right part of the ice maker since it is heavier due to the compressor therein.

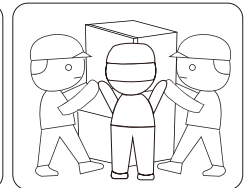

2. As the first phase, put the ice maker on a loading platform. (Height of loading platform: Minimum of 1m(39.4") is recommended)

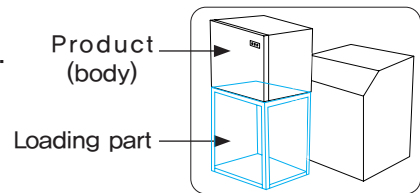

3. As the second phase, move the ice maker from the platform to the top of the bin.

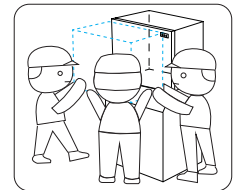

4. Move the main unit of the ice maker on the top backward little by little until the bin and the front door would open safely. (Align back and side.)

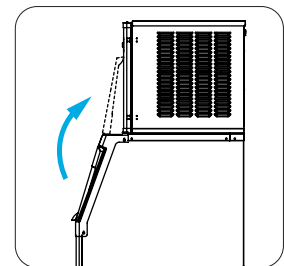

5. Fix the main unit using the fixture or the fixing bracket on the rear side of the main unit so that the main unit would not fall. (The fixing bracket is supplied separately upon customer's request.)

6. Slightly loosen three screws on the back left side of the main unit, assemble the windbreak temporarily, and tighten the screws to fix. (For air-cooled type, you need to install the enclosed windbreak as indicated in the picture to block the hot air from the side panel to improve ice-making.) – for some models only



Place the ice maker on top of the bin and ensure it is fixed. The manufacturer will not be held responsible for the accidents resulting from the ice maker that was not fixed and fell off in use.

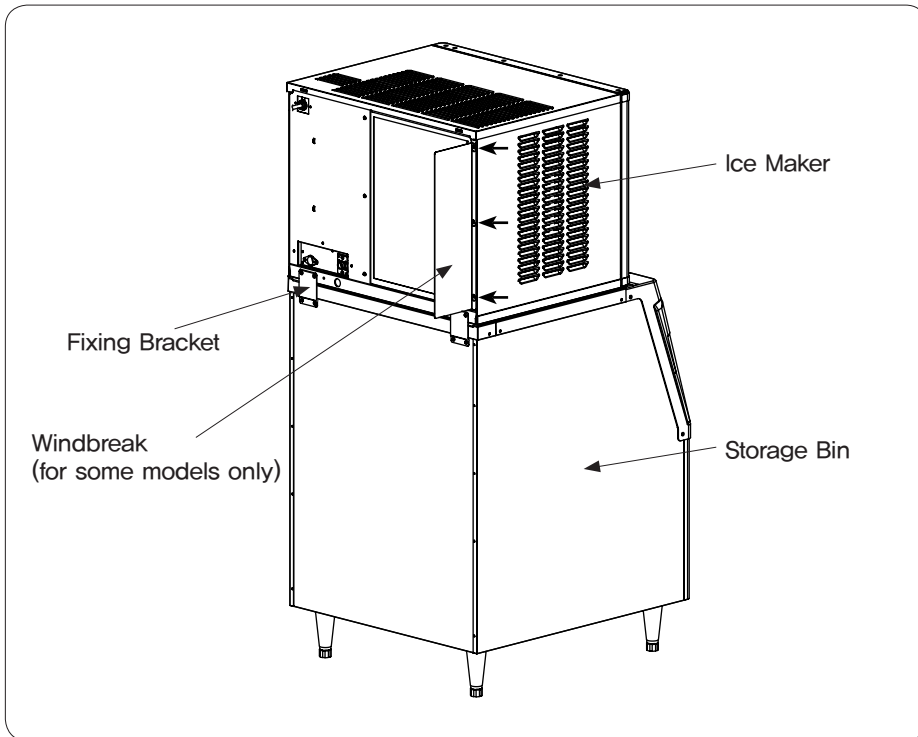

# How to Connect Water Supply and Drain

## [ Water Supply and Drain Hoses Connection ]

Division	Appropriate Water Temperature	Water Pressure	Hose Used
Cooling Water Supply (Water-Cooled)	50 ~ 90 °F (10 ~ 32 °C)	14 ~ 71 psi (0.1 ~ 0.5MPa)	3/8" FPT(NPT)
Cooling Water Drain (Water-Cooled)	—	—	3/4" FPT(NPT)
Ice making Water Supply	50 ~ 90 °F (10 ~ 32 °C)	14 ~ 71 psi (0.1 ~ 0.5MPa)	3/8" FPT(NPT)
Ice Making Drain	—	—	3/4" FPT(NPT)

If the water supply temperature for ice making is too high, the amount of ice made might decrease the amount of ice made and if the water pressure is too low, an auxiliary hydraulic pump must be installed. Connect with a hose that is larger than the socket inner diameter provided by our company, and do not connect the socket in the middle.

**⚠ Failure to observe the above may cause the ice maker to stop working without draining smoothly.**

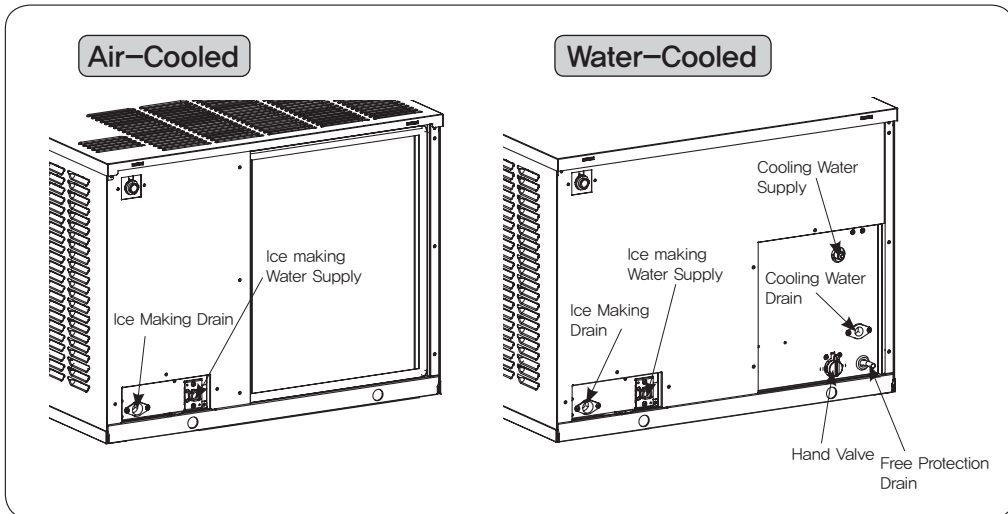

The location of the water supply and drain may vary depending on the model, please refer to the part names (pages 22–27) for accurate details.

Please connect the ice-making drain hose and cooling water drain hose separately.

### ● Installing Auxiliary Drain Hose

When the water stays on the floor in the machine room in the highly humid area, the hole processing unit for drain is located on the rear side of the floor of the machine room.

1. Find a small hole in the shape of a dimple on the rear side of the product with compressor.
2. Bore a  $\varnothing 16\text{mm}$  (5/8") size hole on the dimple shape.  
(Caution: Ensure that it is not greater than  $\varnothing 16\text{mm}$  (5/8").)
3. When it is possible to drain outside
  - Insert a  $\varnothing 12.7\text{mm}$  (1/2") size PVC hose.
  - Apply sealant around the hole into which the hose is inserted to prevent water leakage.
4. Make connections so that the water would drain easily down to the drain.

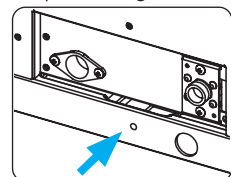

---

---

## [ Coolant Flow Control Valve: Checking and Adjusting Pressure ]

※ If the pressure of the coolant flow control valve is inappropriate, it may use more water or may not produce ice.

※ Please check the user manual to adjust it to appropriate pressure.

1. While the product is "OFF", connect the gauge to the high pressure nipple of the "Freezing Unit".
2. Place the power switch to "ICE" and run the product.
3. Five minutes after running, check whether the gauge pressure matches the setting (refer to product specification).
4. If the setting and gauge pressure do not match, slowly turn the "Coolant Flow Control Valve" with a tool to adjust.

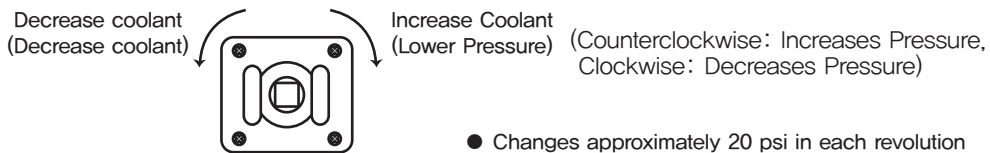

### Warning

#### About water supply and drain connections

After connecting the product water supply and drain, do not allow water droplets (condensate) to fall on the floor.

Please cover it sufficiently with insulation material to prevent damage.

If water falls on the floor and causes damage, the manufacturer is not responsible.

# After Installation

- **Protection of the water supply hose**  
Do not put any heavy object on the water supply hose. Do not step on it either.

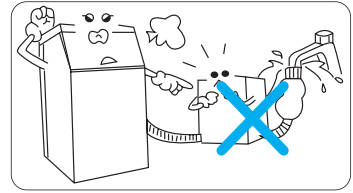

- **The appropriate water pressure, water temperature, or ambient temperature is...**  
This icemaker must be used under conditions of 14~71 psi, water supply of 10~32 °C (50~90 °F), and ambient temperature of 10~38 °C (50~100 °F).



Connect potable water supply only.

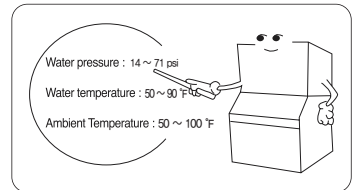

## 1. Plugging into the Power Supply.

- ◆ This icemaker operates only on rating volts.  
Plug it into a rating outlet only.

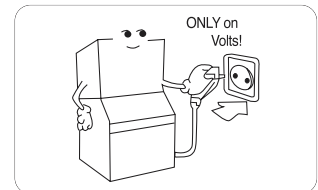

## 2. Supplying Water to the Icemaker.

- ◆ Open the faucet to supply water to the icemaker.

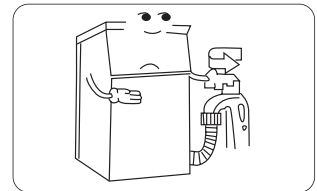

## 3. Ice making

- ◆ Open the Front panel and then Turn on the power switch to start ice making.

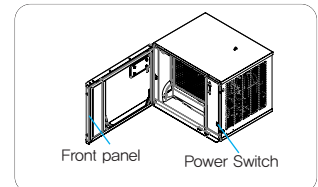

## 4. Ice Making Operation.

- ◆ Although the length of operation time varies depending on the ambient temperature and or the water temperature, one (1) cycle of ice-making operation is completed 20~30 minutes after the operation starts.

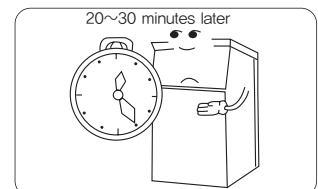

## 5. Operation Guide

### ICE MAKING

1. Place the power switch on the panel parts to 'up (ICE)' to run the machine.

- ◆ When the product begins to run, the water will be supplied to water vessel, and the condenser and water pump will begin to run. (Approximately 20~30 seconds)

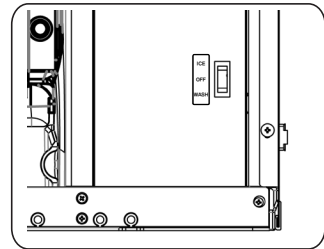

### WASH

1. Place the power switch on the panel parts to 'down (WASH)' to run washing cycle.

- ◆ The washing process will automatically wash the water vessel, water pump, connecting hose, water distributor, and evaporator according to the washing procedure (preset by program).
- ◆ When you place the power switch from 'ICE' → 'WASH', it will begin washing after making and harvest ice.

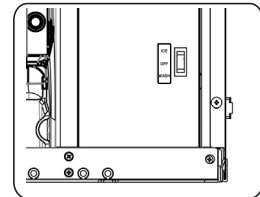

#### [Wash Cycle]

- ① Supply water until the full level (30 seconds) → Run the pump for 10 minutes (Wash) → Drain for 40 seconds
- ② Supply water until the full level (30 seconds) → Run the pump for 1 minute and 30 seconds (Wash) → Drain for 40 seconds (Repeats ② five times)

- ※ For details of washing and sanitizing processes, please refer to 'Cleaning and Disinfection' of section 8 – 'Maintenance, Repair, and Disinfection'.

## OFF

1. Place the power switch on the panel parts in the 'Middle (OFF)' to stop the machine.

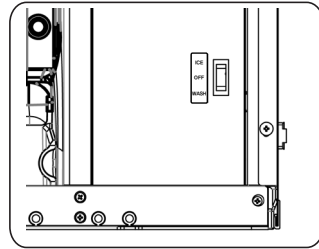

- ◆ When you place the power switch from 'ICE' → 'OFF', the machine will stop after ice making / harvest completes.
- ◆ When you place the power switch from 'WASH' → 'OFF', the machine will stop after the washing cycle ends

## Adjusting Ice Thickness

1. After the harvest cycle ends, adjust the thickness between ice cubes in the bin.  
(Attention: When checking the size of ice, make sure the water curtain is mounted on the ice making chamber so that the ice would not be dispersed in the condenser's harvest cycle.)
2. The standard distance between the thickness detection unit and evaporator is 6~8mm. (Refer to the following picture)
  - If you wish to make thicker ice, turn the adjustment screw clockwise (CW).
  - If you wish to make thinner ice, turn the adjustment screw counterclockwise (CCW).(Caution: Condenser may be overcooled. Make adjustments carefully.)

Ice Thickness Measuring Unit

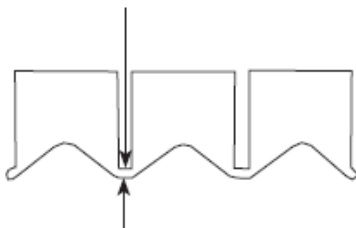

Ice Thickness Adjusting Screw

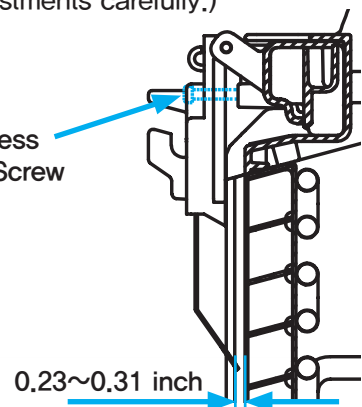

### 3. Water amount control supplying to the water through Ice thickness probe clearance adjustment

Factory  
setting

IM-1106-WC	IM-1106-WH
5.0 mm	4,5 ~ 5,5 mm

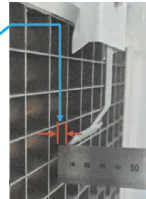

- Ⓐ Open the front door by loosening top and bottom bolts
- Ⓑ Adjust clearance by using adjustment screw on ice thickness probe like picture in right
- Ⓒ If water supply is not enough since adjust ice thickness thicker than factory setting, Please set FND PCB to extend water supply time as under.

- ▶ Press set of FND. Version is showing, then press increase or decrease to move me until the below image appears

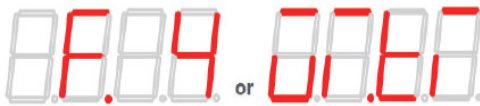

- ▶ Press set and value appears. This value is extended water supplying time. If this setting is done, water is supplying to water through additionally for a certain period of time after high level sensed high level.
  - ▶ Increase time or decrease time by pressing "increase" or "decrease" button. (setting time is second)
- Ⓓ If ice thickness is set thicker, extend water supply time and set thinner decrease water supply time.

## 6. Operating Status Display

Item	Display	Front Indicator Lamp	Action
Power InputS			top (normal status)
Ice Making			Normal operation (run)
Wash		Flickers for 1sec	Normal operation (run)
Full Bin			Stop (normal status)
Clean alarm		Sequential flickers twice for 0.5sec	Notification that 180 days have passed since cleaning (* When setting the function)
Water Supply Trouble		Er 15	Re-operates if the problem is resolved after checking it automatically on every hour.
Drainage error		Er 18 Flickers for 0.2sec	Restarts after 1 hour
High Pressure Detection (1time)		Er 13 Flickers for 0.2sec	High pressure is released and restarts 1 hour later.
Trouble in Ice Making		Er 01 Flickers for 0.2sec	Stop
Ice Making Delay		Er 11 Flickers for 0.2sec	Restarts after 1 hour
Ice Harvest Delay		Er 12 Flickers for 0.2sec	Restarts after 1 hour

## [ Display of Flexible Numeric Display (FND) Module ]

※ Attention: FND module is an optional feature.

This is applied to only the models to which FND module is mounted.

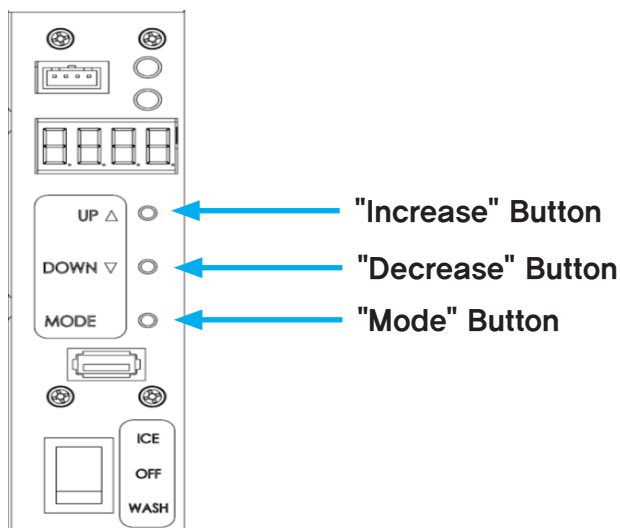

### ● Operating Order

1. In standby mode, FND is off.
2. When you press "MODE" button, FND will turn on and show the program version.
3. While FND is on, press "UP" or "DOWN" button to move to the previous or next item.
4. Move to each item and press "MODE" button to see the default value on FND.
5. Change setting with "UP" or "DOWN" button, and press "MODE" button to save to move to upper item.
6. Press "MODE" button on simple display item to display the corresponding value and press "MODE" button again to move to upper item.
7. It will turn off automatically when it has no input for 30 seconds.  
Or press "MODE" button for more than 3 seconds to turn it off.









### ● Forced Harvest

- Press "UP" + "DOWN" buttons simultaneous for 3 seconds to perform forced harvest.
- ※ Please avoid using this function unless repair service is needed.

### ● Forced Drain

- Press "DOWN" + "MODE" buttons simultaneous for 3 seconds to perform forced drain (30 seconds).

## [ Display and How to Use it]

Item	Display	Description
Air Sensor Temperature		<ol style="list-style-type: none"> <li>1. Displays the current air temperature at surroundings.</li> <li>2. If not used, it is displayed as 'none'.</li> </ol>
Water Temperature		<ol style="list-style-type: none"> <li>1. Displays current water temperature in the water vessel.</li> <li>2. If not used, it is displayed as 'none'.</li> </ol>
Discharge Temperature		<ol style="list-style-type: none"> <li>1. Displays current temperature of the discharge.</li> <li>2. If not used, it is displayed as 'none'.</li> </ol>
Condenser Outlet Temperature		<ol style="list-style-type: none"> <li>1. Displays current temperature at the condenser outlet.</li> <li>2. If not used, it is displayed as 'none'.</li> </ol>
Evaporator Inlet Temperature		<ol style="list-style-type: none"> <li>1. Displays the current temperature at the evaporator inlet.</li> <li>2. If not used, it is displayed as 'none'.</li> </ol>
Evaporator Outlet Temperature		<ol style="list-style-type: none"> <li>1. Displays the current temperature at the evaporator outlet.</li> <li>2. If not used, it is displayed as 'none'.</li> </ol>
Suction Temperature		<ol style="list-style-type: none"> <li>1. Displays the current temperature at the suction.</li> <li>2. If not used, it is displayed as 'none'.</li> </ol>
Safety Temperature		<ol style="list-style-type: none"> <li>1. Displays the current temperature at the safety sensor.</li> <li>2. If not used, it is displayed as 'none'.</li> </ol>

# 7. Removal from Service/Winterization

## General

Special precautions must be taken if the ice machine is to be removed from service for an extended period of time or exposed to ambient temperatures of 32° F (0° C) or below.

---

## Water-cooled ICE MACHINES

1. Perform steps 1–6 under “Self-Contained Air-Cooled Ice Machines.”
2. Disconnect the incoming water and drain line from the water-cooled condenser.
3. Remove the cover from the control box and push in the contactor so that the compressor starts. The increasing refrigerant pressure will open the water regulating valve.
4. Blow compressed air through the condenser until no water remains.  
Only a qualified refrigeration technician should be used to winterize any water-cooled ice machine.

# 8. Maintenance, Repair, and Disinfection

## Disassembling Parts for Washing and Disinfection

### 1. Disassembly of Water Curtain

- ① Hold the bottom side of the water curtain with both hands, slightly pull to the front, and push upward to remove.

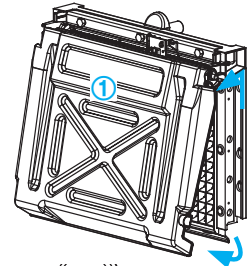

### 2. Disassembly of Ice Thickness Sensor

- ① Press both hinges on the top side of the ice thickness sensor and pull to the front to remove.
- ② To remove ice thickness sensor and wiring from the ice making chamber, remove the top cover of the ice making chamber and remove the connector connected to the electronic unit.

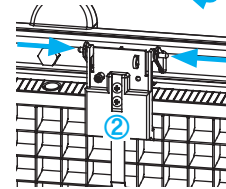

### 3. Disassembly of Water Vessel

- ① Twist both hands and pull both projections on the front side of the water vessel.
- ② When the projections on both sides are released from the grooves, hold the front side of the water vessel with hands, pull to the front side slightly, pull downward to remove in a way that the stop bumps(three) on the back side would be released.

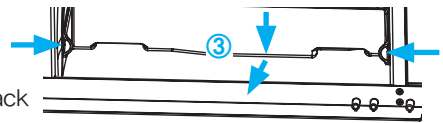

※ Caution: When removing or inserting the water vessel, ensure it does not interrupt water level sensor and water pump.

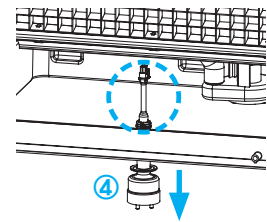

### 4. Disassembly of Water Level Sensor

- ① Hold the water level sensor's body and pull downward until the connector appears.
- ② Separate connector and remove from the bottom of the product.

※ Caution: Ensure that the water in the location does not come onto the connector.

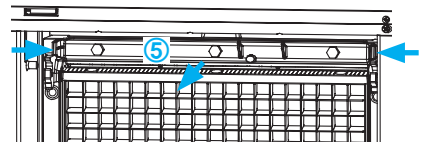

### 5. Disassembly of Water Distributor

- ① Press the clamp on both wings of the water distributor inward and pull it toward the front to remove.
- ② Loosen the screws that connect the body and the cover to disassemble.

### 6. Remove Air Filter

- ① Pull the handle of the air filter to the front and remove to the side.

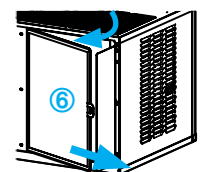

---

---

# Cleaning and Disinfection

- **General**

The end user has the responsibility to take good care of and repair this ice maker according to the descriptions of this manual.

The insurance does not cover the maintenance procedure.

Basic sanitation and the maintenance and repair of ice maker will enhance reliability and performance and also reduce water consumption and power consumption.

You can minimize unwanted repairs caused by maintenance if you manage the ice maker according to our rules.

The following table shows the maintenance activities that end consumers and service personnel must perform and how often they need to perform them.

These figures indicate the minimum requirement. If low-quality water is supplied to the ice maker, you will have to clean the evaporator more often. If the condenser's air filter is completely clogged, it needs to be cleaned more often such as every week.

※**Warning:** If you do not fully understand the essential safety rules and procedures, please contact our agency to perform necessary repair.

## [ Cleaning and Disinfecting Inside ]

- **General**

Clean and disinfect the ice maker every six month for efficient operation.

If the ice maker needs to be cleaned and disinfected more often, consult a certified service company to check water quality and take necessary actions.

If the condition inside the ice maker is not acceptable, disassemble key parts of the ice maker for cleaning and disinfection.

※**Caution:** Please use proven ice maker cleaning agent and disinfectant. (The cleaning agent is only available from us or our agency.)

Please read and fully understand the label printed on the storage bin before use in advance.  
Do not mix ice maker cleaning agent and disinfectant.

The type and concentration of sanitizing agent(Ice Maker Cleaner, Sanitizer, mild or neutral detergent, and so forth)recommended

Comply with 40 CFR 180.9403 or

Be registered with the USA Office of pesticides program Antimicrobials Division

As a food contact sanitizer and

– If produced by a device, as defined per 40 CFR 152.5003, be demonstrable to be efficacious per USEPA performance. The device shall maintain a USEPA Site manufacturing device establishment number and

– If produced by a device, as defined per 40 CFR 152.5003, have in place and readily discernable to the operator a monitor or indicating device that the device is producing adequate amounts of sanitizing agent during the sanitization operation.

※**Warning:** Wear rubber gloves and goggles (or face mask) when using cleaning agent or disinfectant.

- **Washing Method**

Ice maker cleaning agent is used to remove lime trace and other mineral sediments.

It is not designed for removing fur or sticky mucous substance.

Refer to "Disinfection" section in the next page about removing fur or sticky mucous substance.

Mix 150ml of cleaning agent and 4 liters of water in a plastic or stainless storage bin.

Cleaning Agent (Nickel Safe Cleaner)	Water
150 ml (16 oz)	4 Liters
Disinfectant (5.25% Sodium Hypochlorite)	Water
200 ml	5 Liters

---

Step 1: After the ice falls off the evaporator, turn off the switch in the final stage of ice harvest cycle.  
Or place the switch to OFF to stop automatically after making and harvest ice.

※ **Caution:** Do not remove ice from evaporator by force. It could damage evaporator.

Step 2: Remove all ice inside the bin. (To use ice later, keep it in an appropriate storage bin.)

※ **Warning:** Shut the power to the ice maker in the electric switch box before going further.  
(Set the earth-leakage breaker to off or turn the ice maker's switch to off.)

Step 3: Our ice makers generally come in two types. They have different disassembly methods and parts.  
Please take cautions when disassembling parts.

- ① Cubic Type : If necessary, remove the top cover, and disassemble evaporator cover, water curtain (piano-shape part—some products need to disassemble the bolts from the front side), ice guide (the part designed to guide the falling ice into the bin), nozzle frame (the part to which the water spraying nozzle is attached).
- ② Vertical Type : If necessary, remove the top cover and disassemble the water curtain (the cover which prevents water splash in the front side — push to the right completely to remove the trapping on the left to disassemble). You do not need to disassemble thickness sensor and water supply pipe.

Step 4: Put all components in 1 liter (3 liters for cubic type) of cleaning agent–water mixture and clean with soft nylon brush.

Remove spray bar (remove silicon cap on left/right), separate nozzle and inserts, and soak them in the mixture for five minutes. (Cubic Type)

If the lime has built up thickly, soak them in the mixture for 15 – 20 minutes.

Shake the parts from time to time and use warm water for better results. For Cubic Type, use a toothbrush to clean between nozzles.

After cleaning, rinse all parts with clean water.

Step 5: While you are soaking all parts in the cleaning mixture, use a soft brush to scrub the inside of the ice bin.

Scrub inner door, door rail, bin, and evaporator frame thoroughly and rinse with clean water.

For Cubic Type icemaker, clean the top pipe area of the evaporator, also.

Step 6: After cleaning, place the parts back and pour 3 liters (1 liter for clear type) of the remaining mixture into the bin.

Step 7: Connect power to the ice maker. (The switch of the ice maker is OFF)

Step 8: To start automatic washing, place the switch to WASH.

Step 9: After cleaning, (Cubic Type takes approximately 21 minutes and Vertical Type, approximately 30 minutes), place the switch to OFF.

When the cleaning agent remains inside the water vessel, use the drain plug to remove cleaning solution.

For Cubic Type ice maker, place the drain plug again, pour 1 liter of water in the bin, place the switch to WASH, and circulate water again. (WASH function). For Vertical Type ice maker with water supply/drain valve automatically washes and fills it with water.

---

Step 10: When cleaning and rinsing ends, the lime substance will be removed.

If it was not rinsed completely and bubbles are forming inside the water vessel and so on, perform Step 9 again.

Step 11: Washing completes in Step 10. Step 11 is disinfection. You must disinfect the ice maker at least once a month.

Soak all components from Step 3 in 2 liters of disinfectant–water mixture for 10 minutes to disinfect. If the part is large, pour or spray the disinfectant–water mixture on the surface. When the disinfection completes, rinse all components with clean water (use the water directly from the tap to prevent cross infection).

Step 12: Using the disinfectant–water mixture and soft brush, scrub the inside the ice bin. Scrub inner door, door rail, bin, and evaporator frame thoroughly and rinse with clean water (use the water directly from the tap to prevent cross infection.)

Step 13: Reassemble the components disassembled in Step 11 and keep the switch to OFF.

Step 14: Before running the disinfection cycle, pour 3 liters of disinfectant and water mixture in the water vessel. To run the automatic disinfection cycle, placed the switch to WASH. The disinfectant–water mixture will automatically flow inside the pipe to disinfect the machine.

Step 15: After auto wash, (Cubic Type takes approximately 21 minutes and Vertical Type, approximately 30 minutes), turn the switch to OFF.

If disinfectant solution remains inside the water vessel, use the drain plug to remove disinfectant solution. For Cubic Type ice maker, place the drain plug again, pour 1 liter of water in the bin, place the switch to WASH, and circulate water again. (WASH function). For Vertical Type ice maker with water supply /drain valve automatically washes and fills it with water. After washing, remove the drain plug and drain the remaining disinfectant mixture, gently wash with tap water, and dry naturally. Do not wipe the inside with dry cloth to prevent cross infection.

Step 16: Place the switch to ICE and run the ice maker. The ice maker normally enters the ice making cycle. Scrap the very first ice you made. Use from the second ice you make.

### [ Cleaning Air Filter ]

Clean with warm water (approximately 25°C) or the water mixed with neutral cleaning agent at least once a month, dry fully, and reassemble again.

※ Warning: When the filter is covered with dust and does not ventilate well, it may become difficult to make ice or may cause malfunction.



Caution



Warning

- Clean the ice scooper regularly. Clean it with other food storage bins.
- The handle of the ice scooper can be easily exposed to germs by hands.
- The cleaning agent may cause burn.
- If you ingested cleaning agent, do not force yourself to vomit the cleaning agent.
- Drink lots of water or milk and consult your doctor immediately.
- If your skin contacted the cleaning agent, clean with water.
- Keep the cleaning agent out of children's reach.

## Precautions for cleaning

For parts containing electrical and electronic devices, be careful not to allow cleaning liquid or water to come into contact with the electrical devices and connectors. Clean only the area shown in the following picture by immersing it in the cleaning solution and clean the rest of the area with a soft nylon brush.

※ Caution : Water contact may cause failure

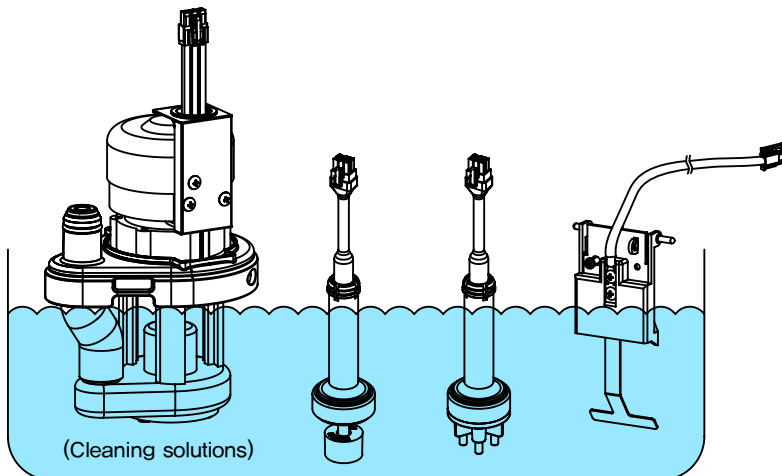

**Caution**

The inside of the ice maker may be contaminated depending on the surrounding environment or hygiene management during use.

Due to the nature of ice making using water, foreign substances such as mold, bacteria, and scale may occur.

Contamination inside the ice maker during use of the product is not guaranteed by the manufacturer. Regular cleaning with cleaning agents and disinfectants is recommended at least once a month.

If necessary, it may be necessary to manage it through a specialized company, and please use hygienic ice through regular cleaning and handling.

---

---

## Cautions for cleaning the external panel(stainless steel)

※ Regular wash for stainless can prevent rust.

※ How to remove rust

How to clean rusted parts

### 1. Rust spots in early stage

- Rust spots in early stage mean that the stainless steel itself is not severely affected, thus mild detergent or any commercially available cleaning agent will restore original state. Rust will be removed with ease and at low cost if regular cleaning is done at appropriate intervals.

### 2. Red rust

- Rust spots that are not removed after a short period of time will turn into thick reddish–brown rust and will damage the surface of the stainless steel. These are much harder to remove and the surface will not be fully restored; thus, it is important to remove rust spots early on.

If commercially available cleaning agents do not work, use sandpaper or a stainless steel brush to remove the rust before applying the agent for easier removal.

This process requires treatment, such as refurbishment after cleaning.

### 3. Rust from iron

- Rust from coming into contact with welding spatter, rust from the metal bar above the stainless steel part, or contact between the stainless steel parts and general metal parts are caused galvanic corrosion. This causes the metal to rust first, and it will eventually cause the stainless steel to rust too if it is not removed. As such, make sure to clean and remove rust immediately with a mild detergent. However, when the rust has gotten really bad, it must be removed with 15% nitric acid solution or commercially available stainless steel cleaner.

### 4. Rust from exhaust gas or acid rain

- In environments, such as a factory complex or heavy transport sites, the product will become contaminated in a short amount of time due to exhaust fumes or acid rain and rust spots will quickly form. Light rust can be washed off with a mild detergent or soapy water, but heavy rust will require 15% nitric acid solution or commercially available stainless steel cleaner.

### 5. Rust from salt deposit

- In environments, such as windowsills or pipes on the porches of an apartment complex, that are close to the seashore where the product may be directly exposed to the sea winds, STS304 or STS316 will get rusted in no time, and this will occur much faster than in other types of environments. These cases require special treatment, such as using painted stainless steel or regular cleaning.

### 6. Rusts from disinfectants or cleaning agents

- Sites, such as pools or public baths, that use chlorine–based agents to sterilize the water, especially those for cleaning bathrooms, contain chlorine content that attaches to and rusts the stainless steel surface. Thus, it is important to thoroughly wash off such agents after using them, and a 15% nitric acid solution or commercially available stainless steel cleaner are required for removing this type of rust.

# 9. Type of Product Error

Type of Error	Display		Cause	What to Do	Release	Action
	Front Indicator Lamp	Error Code				
Full Bin		-	The bin is filled with ice.	Use of ice	Automatically release when the bin is emptied.	Stop
Water Supply Trouble		Er15	Water for making ice is not supplied within the required time. (Max 5 mins or less)	Check water supply connection	Reconnect power after resolving water supply problem.	Stop
Drainage error		Er18	The pump water does not drain.	Check drain valve and drain line. Check water level sensor.	Reconnect power after resolving cooling problem.	Auto restart after 1 hr after stop
Trouble in Ice Making		Er01	When the outlet temperature of the evaporator reaches 0°C, 30 mins after the ice making started.	Check cooling unit(Inquiry Service Center when there is a problem)	Reconnect power after resolving cooling problem.	Stop
Poor Ice Making		Er03	When the outlet temperature of the evaporator reaches exceeds -5°C, 30 mins after the ice making started.		Reconnect power after resolving cooling problem.	Run
Ice Making Delay		Er11	It flickers when the maximum ice-making time (65 mins) is exceeded.		Clean ice thickness sensor. Reconnect power after resolving cooling problem.	Auto restart after 1hr after stop
Ice Harvest Delay		Er12	It flickers when the maximum harvest time (5 mins) is exceeded.		Clean/inspect water curtain and right magnet detection unit. Reconnect power after resolving cooling problem.	Auto restart after 1hr after stop
High Pressure Detection		Er13	Fan motor failure / The water does not cool down the gas(High pressure s/w is open) / Condenser clogged	Check fan motor and condenser. Check water supply line of the cooling unit(Inquiry Service Center when there is a problem)	Reconnect power after resolving the cooling water supply problem.	Auto restart after 1hr after stop

# 10. Before Contacting Service Center

If the machine is not operating as it is expected to, please check the following.  
 If the machine does not operate properly afterwards, please contact the retailer you purchased the product from or the service center.  
 When you contact the retailer or service center, please inform them the following thoroughly.  
 (Model name, manufacturer's serial, agency that sold the machine, date of purchase and the detailed description of the current state)

Operating Status	Checklist	What to do
1. Machine is Not Working	1. Is the power supplied?	1. Supply power.
	2. Is the power supply of the machine using correctly?	2. Check power and use exclusive outlet.
	3. Is the 3-step switch turned to ice?	3. If on 'OFF' or 'WASH', turn to 'ICE'.
	4. Is the water curtain open?	4. Eliminate the cause and close.
2. Takes Too Long to Make Ice	1. Machine is too dirty.	1. Clean as indicated in 'Clause 6'.
	2. Ambient temperature is too low.	2. Adjust ambient temperature to 50 °F or greater.
	3. Dregs remaining in the coolant flow control valve.	3. Clean the valve as indicated in 'Clause 6'.
	4. Ice thickness is too widely set.	4. Adjust to 0.23~0.31 inches.
3. Ice is Too Small or Dirty.	1. Water supply pressure is too weak.	1. Raise the supply pressure. Clean the strainer on the back.
	2. Machine is too dirty.	2. Clean as indicated in 'Clause 6'.
4. Does Not Form or Make Easily.	1. Ice thickness adjustment sensor is malfunctioning.	1. Maintain at around 0.23~0.31 inches by adjusting the sensor screw.
	2. Water supply level is too low or high.	2. Adjust water supply delay time.
	3. Water supply valve failure.	3. Check normal operation.
	4. Strainer is blocked.	4. Disassemble and clean the strainer on the back.
	5. Water supply temperature and pressure are high.	5. Refer to '3-2'.
5. Ice Producing Amount is Too Small	1. Supplied water is dirty.	1. Clean as indicated in 'Clause 6'.
	2. Insufficient water supply.	2. Check water pressure or water outage.
	3. Condenser is dirty.	3. Clean the filter on the back for air-cooled condenser.
	4. Ambient temperature is too high.	4. Ambient temperature should be less than 100 °F.
6. Water Standing inside Bin	1. Drain is higher than bin.	1. Ensure that the drain is lower than bin.
	2. Drain is clogged.	2. Clean the hose.

---

## REFRIGERANT CHARGING

No air is ever to be allowed inside the refrigeration system (R-290 refrigerant or dry nitrogen only).

Ensure that contamination of different refrigerants does not occur when using charging equipment. Hoses or lines shall be as short as possible to minimize the amount of refrigerant contained in them.

Cylinders shall be kept in an appropriate position according to the instructions.

Ensure that the REFRIGERATING SYSTEM is earthed prior to charging the system with refrigerant.

Prior to recharging the system, it shall be pressure-tested with the appropriate purging gas.

The system shall be leak-tested on completion of charging but prior to commissioning.

A follow up leak test shall be carried out prior to leaving the site.

## REFRIGERANT RECOVERY

R-290 has been exempted from recovery/reclaiming requirements by the US EPA.

Recovery/Reclaiming equipment must be approved for use with R-290.

When transferring refrigerant into cylinders, ensure that only appropriate refrigerant recovery cylinders are employed.

Do not mix refrigerants in recovery units and especially not in cylinders.

Do not overfill cylinders (no more than 80 % volume liquid charge).



### Warning

- Only skilled and well-trained service technicians permitted to service R-290 equipped products.

---

## SYSTEM REPAIR

- Be aware that malfunction of the equipment can be caused by refrigerant loss and a refrigerant leak is possible.
- Discharge capacitors in a way that won't cause any spark.
- When brazing is required, Safely remove the refrigerant following local and national regulations. Take care that the drained refrigerant will not cause any danger. Take special care that drained refrigerant will not float back into the building.
- Carry out a leak test before charging with refrigerant.

## DECOMMISSIONING / DISPOSAL

If the unit is being removed from service for disposal, check and obey all federal, state, and local regulations regarding the disposal and recycling of refrigeration appliances, and follow these steps completely:

- Remove all consumable contents from the unit.
- Unplug the electrical cord from its socket.
- Remove the door(s)/drawer(s).
- The REFRIGERANT CHARGE is to be removed before decommissioning.
- Ensure sufficient ventilation at the equipment location.
- Discharge capacitors in a way that will not cause any spark.
- Put a label on the equipment that the refrigerant is removed.
- Cut out the compressor and drain the oil.

## COMPRESSOR REPAIR



### Danger

- Failure to follow electrical safety measures may result in serious injury, fire or death.
- Never handle the unit in wet conditions as this can pose a severe danger of electric shock.
- Burns from hot or cold surfaces can cause serious injury.



### Warning

- Only skilled and well-trained service technicians permitted to service R-290 equipped products.

Online Internet Service  
<http://www.icetro.com>

